

(F21)

**VF\_F**

**B8**

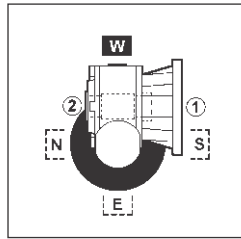
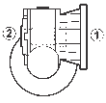

VF\_ B8 + V\_ B3 1

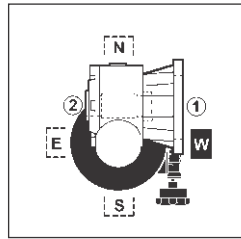

VF\_ B8 + V\_ B6 1

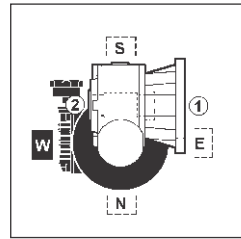

VF\_ B8 + V\_ B7 1

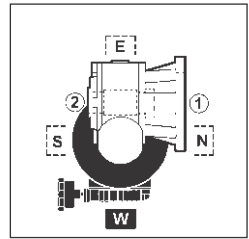

VF\_ B8 + V\_ B8 1

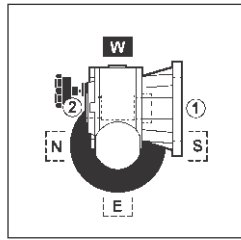

VF\_ B8 + V\_ B3 2

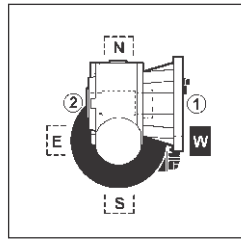

VF\_ B8 + V\_ B6 2

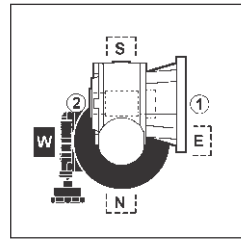

VF\_ B8 + V\_ B7 2

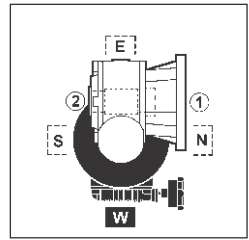

VF\_ B8 + V\_ B8 2

**VF\_F**

**V5**

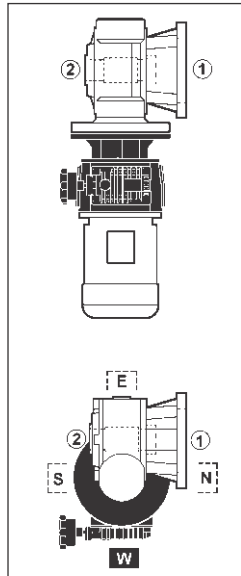
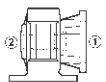

VF\_ V5 + V\_ V6 1

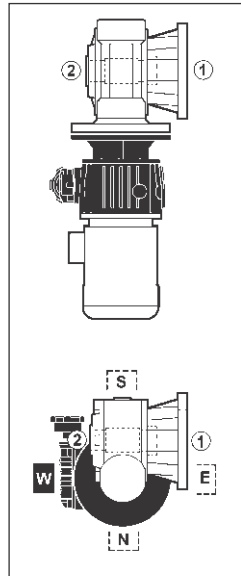

VF\_ V5 + V\_ V61 1

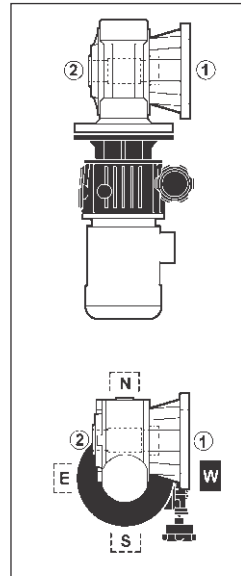

VF\_ V5 + V\_ V63 1

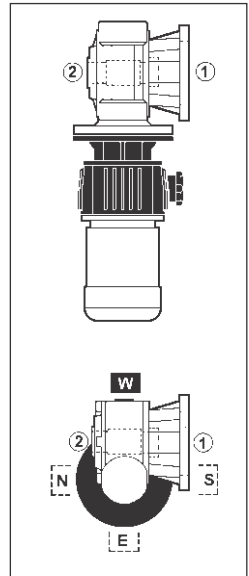

VF\_ V5 + V\_ V62 1

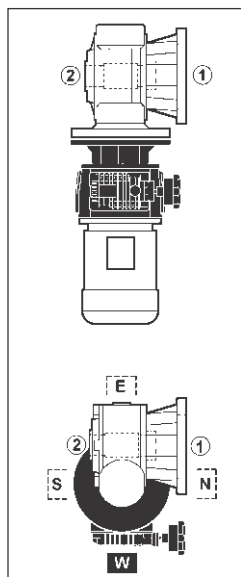

VF\_ V5 + V\_ V6 2

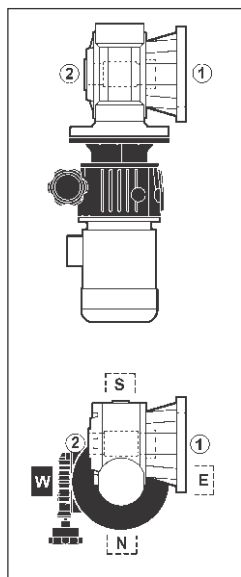

VF\_ V5 + V\_ V61 2

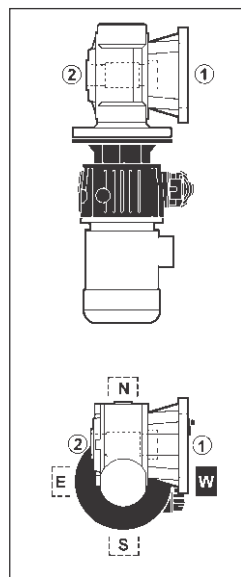

VF\_ V5 + V\_ V63 2

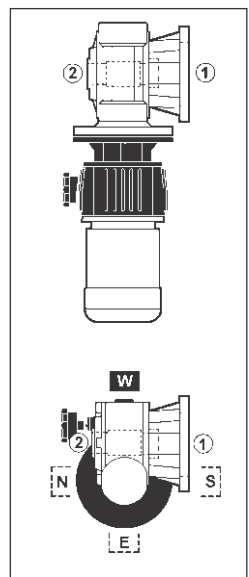

VF\_ V5 + V\_ V62 2

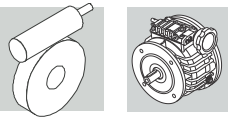

(F22)

**VF\_F**

**V6**

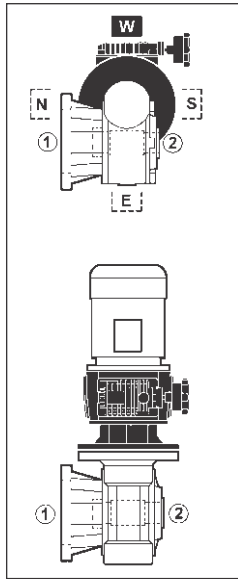
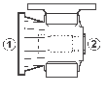

VF\_V6 + V\_V5 1

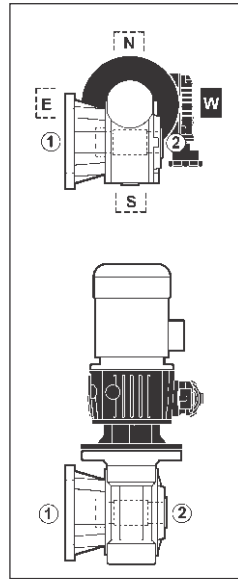

VF\_V6 + V\_V51 1

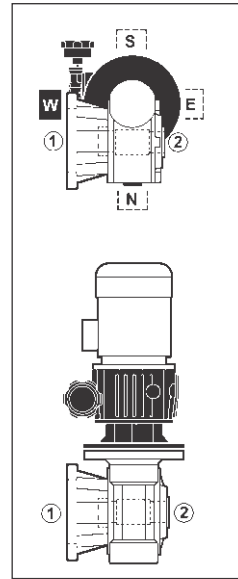

VF\_V6 + V\_V53 1

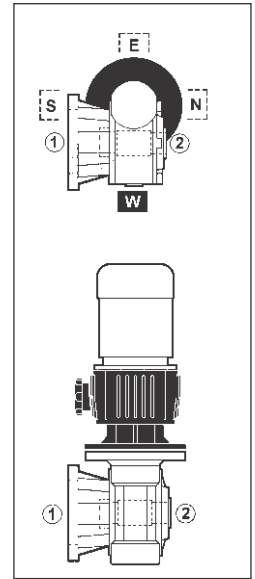

VF\_V6 + V\_V52 1

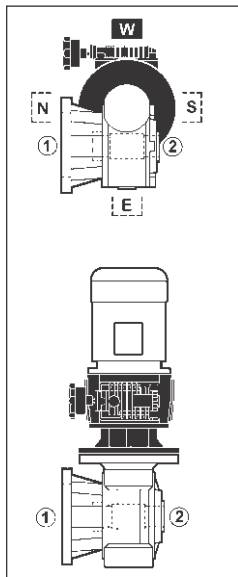

VF\_V6 + V\_V5 2

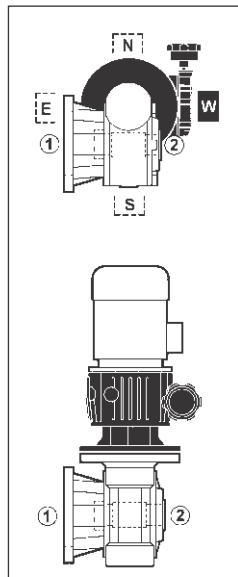

VF\_V6 + V\_V51 2

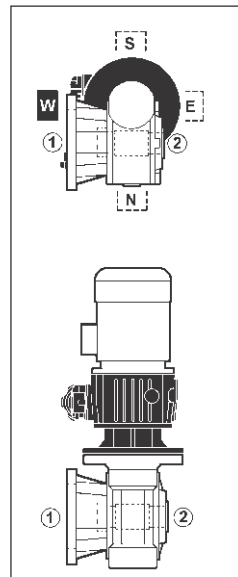

VF\_V6 + V\_V53 2

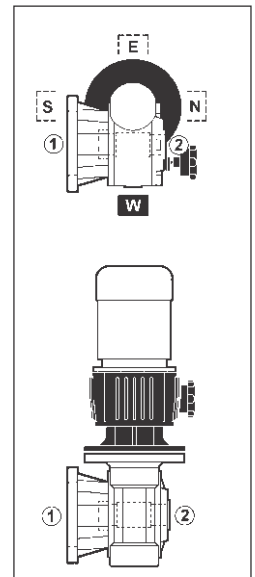

VF\_V6 + V\_V52 2

① ② Posizione flangia / Flange position / Flanschlage / Position bride

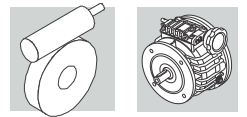

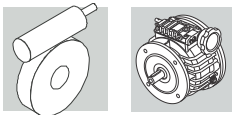

(F23)

<div data-bbox="129 255 280 315" style="border: 1px solid black; padding: 5px; font-weight: bold;">VF_P</div> <div data-bbox="331 255 416 309" style="border: 1px solid black; padding: 5px; font-weight: bold; font-size: 1.5em;">B3</div> <div data-bbox="156 349 239 439" style="text-align: center;"> </div>						
	<div data-bbox="129 869 280 929" style="border: 1px solid black; padding: 5px; font-weight: bold;">VF_P</div> <div data-bbox="331 869 416 922" style="border: 1px solid black; padding: 5px; font-weight: bold; font-size: 1.5em;">B6</div> <div data-bbox="156 967 236 1048" style="text-align: center;"> </div>					
		<div data-bbox="129 1480 280 1541" style="border: 1px solid black; padding: 5px; font-weight: bold;">VF_P</div> <div data-bbox="331 1480 416 1534" style="border: 1px solid black; padding: 5px; font-weight: bold; font-size: 1.5em;">B7</div> <div data-bbox="156 1579 236 1659" style="text-align: center;"> </div>				

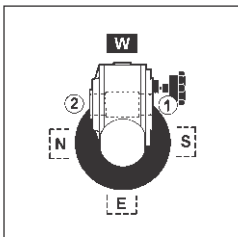
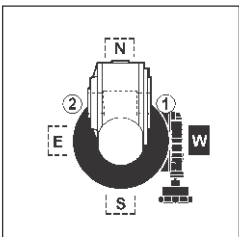
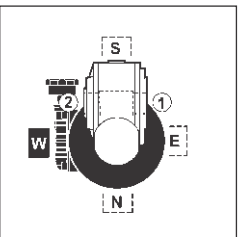
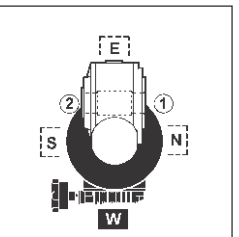
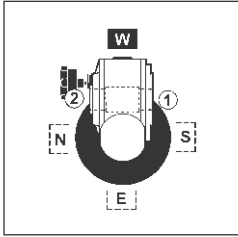
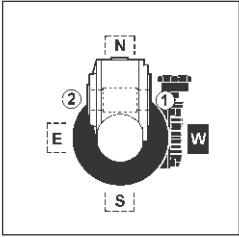
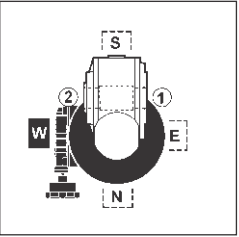
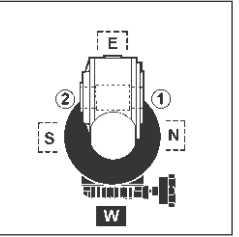

(F24)

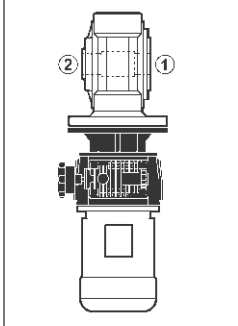
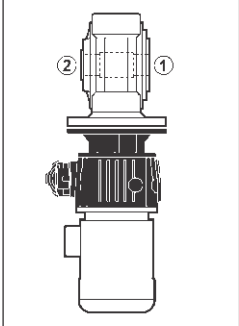
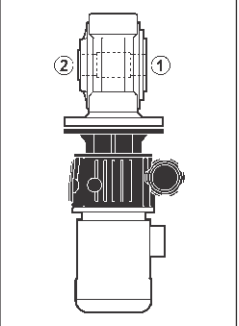
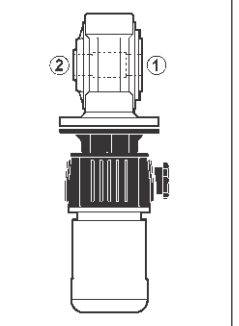
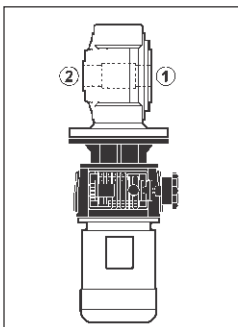
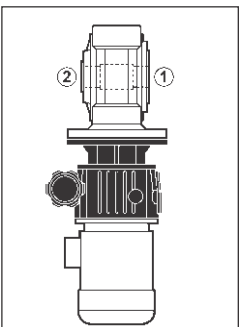
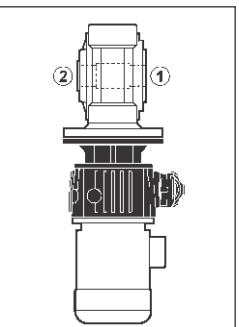
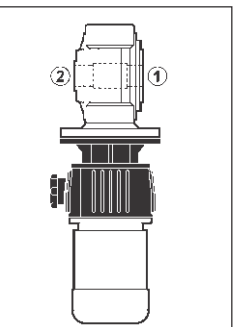
<b>VF_P</b> 	<b>B8</b>				
		VF_ B8 + V_ B3 1	VF_ B8 + V_ B6 1	VF_ B8 + V_ B7 1	VF_ B8 + V_ B8 1
					
		VF_ B8 + V_ B3 2	VF_ B8 + V_ B6 2	VF_ B8 + V_ B7 2	VF_ B8 + V_ B8 2
<b>VF_P</b> 	<b>V5</b>				
		VF_ V5 + V_ V6 1	VF_ V5 + V_ V61 1	VF_ V5 + V_ V63 1	VF_ V5 + V_ V62 1
					
		VF_ V5 + V_ V6 2	VF_ V5 + V_ V61 2	VF_ V5 + V_ V63 2	VF_ V5 + V_ V62 2

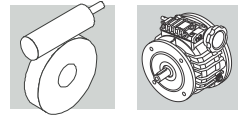

(F25)

**VF\_P**

**V6**

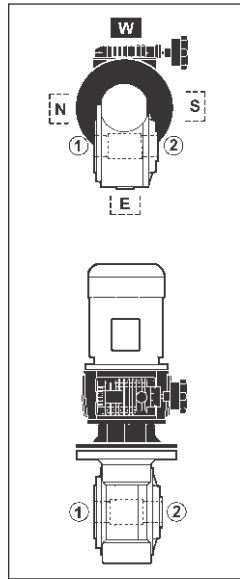

VF\_ V6 + V\_ **V5 1**

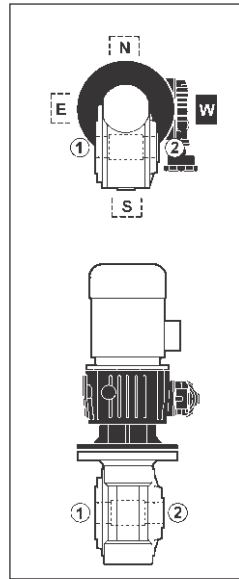

VF\_ V6 + V\_ **V51 1**

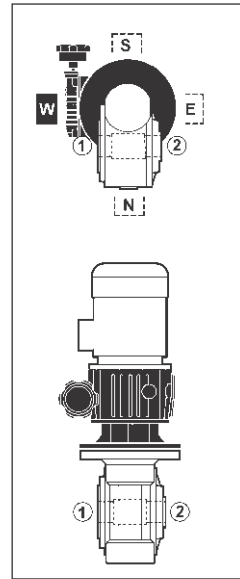

VF\_ V6 + V\_ **V53 1**

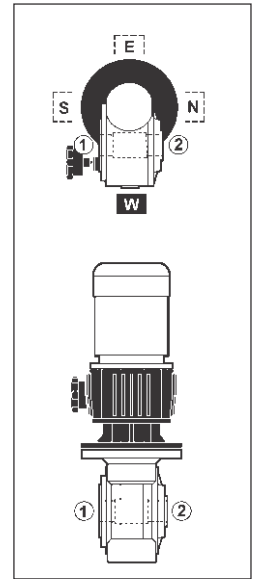

VF\_ V6 + V\_ **V52 1**

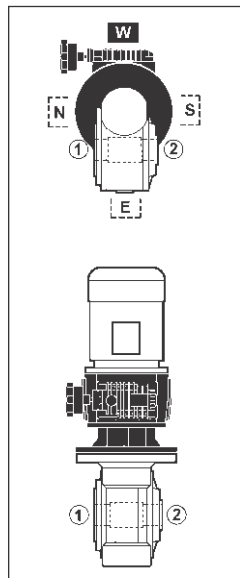

VF\_ V6 + V\_ **V5 2**

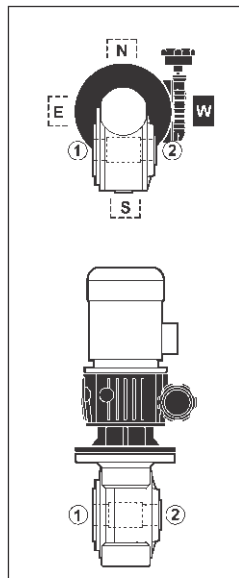

VF\_ V6 + V\_ **V51 2**

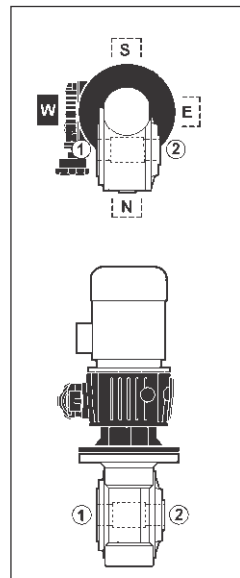

VF\_ V6 + V\_ **V53 2**

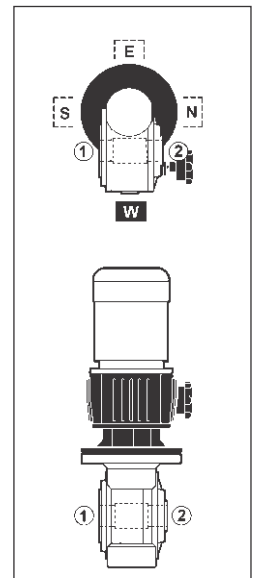

VF\_ V6 + V\_ **V52 2**

① ② Posizione flangia / Flange position / Flanschlage / Position bride

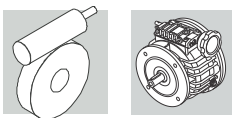

(F26)

<p><b>W_U</b></p>	<p><b>B3</b></p>				
		<p>W_ B3 + V_ B3 1-2</p>	<p>W_ B3 + V_ B6 1-2</p>	<p>W_ B3 + V_ B7 1-2</p>	<p>W_ B3 + V_ B8 1-2</p>
<p>W_U_B3 W_UF_B3 W_UFC_B3</p>					
<p><b>W_U</b></p>	<p><b>B6</b></p>				
		<p>W_ B6 + V_ B3 1-2</p>	<p>W_ B6 + V_ B6 1-2</p>	<p>W_ B6 + V_ B7 1-2</p>	<p>W_ B6 + V_ B8 1-2</p>
<p>W_U_B6 W_UF_B6 W_UFC_B6</p>					
<p><b>W_U</b></p>	<p><b>B7</b></p>				
		<p>W_ B7 + V_ B3 1-2</p>	<p>W_ B7 + V_ B6 1-2</p>	<p>W_ B7 + V_ B7 1-2</p>	<p>W_ B7 + V_ B8 1-2</p>
<p>W_U_B7 W_UF_B7 W_UFC_B7</p>					
<p><b>W_U</b></p>	<p><b>B8</b></p>				
		<p>W_ B8 + V_ B3 1-2</p>	<p>W_ B8 + V_ B6 1-2</p>	<p>W_ B8 + V_ B7 1-2</p>	<p>W_ B8 + V_ B8 1-2</p>
<p>W_U_B8 W_UF_B8 W_UFC_B8</p>					

① ② Posizione dispositivo di comando / Speed knob position / Eibaulage der Verstelleinrichtung / Position commande : 1 default, 2 (V 3...V 10)

① ② Posizione flangia / Flange position / Flanschlage / Position bride

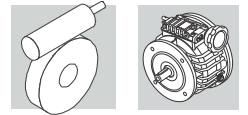

(F27)

**W\_U**

**V5**

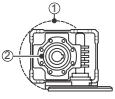

W\_U\_V5  
W\_UF\_V5  
W\_UFC\_V5

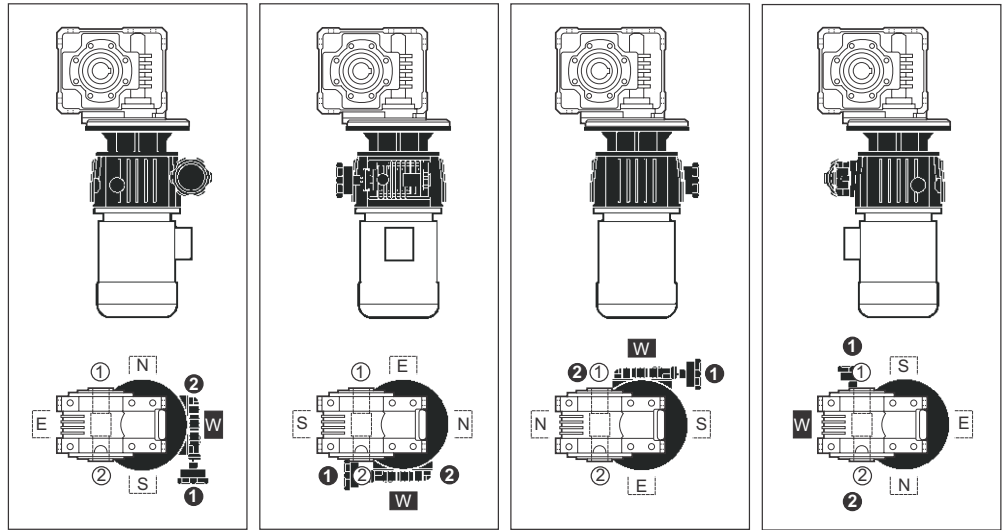

W\_ V5 + V\_ V6 1-2    W\_ V5 + V\_ V61 1-2    W\_ V5 + V\_ V63 1-2    W\_ V5 + V\_ 62 1-2

**W\_U**

**V6**

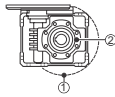

W\_U\_V6  
W\_UF\_V6  
W\_UFC\_V6

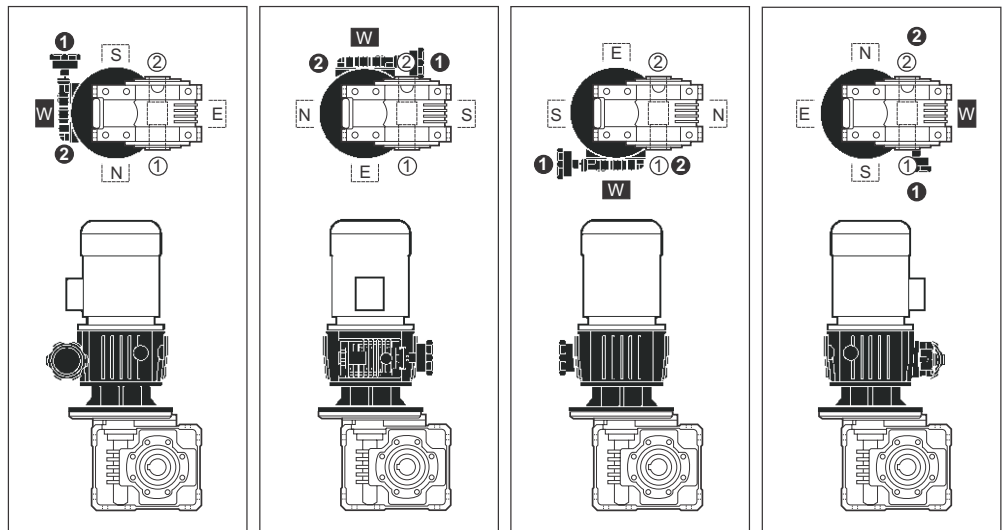

W\_ V6 + V\_ V5 1-2    W\_ V6 + V\_ V51 1-2    W\_ V6 + V\_ V53 1-2    W\_ V6 + V\_ V52 1-2

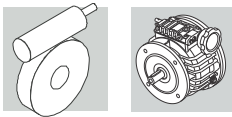

## 0.12 kW

$n_2$ min <sup>-1</sup>	$n_2'$ min <sup>-1</sup>	$M_2$ Nm	$M_2'$ Nm	S	S'	i	R <sub>n2</sub> N	V-	C				
7.6	1.6	50	127	1.2	0.5	80	3450	VF 49_80	V025 P63	V 0.25 C V 0.25 F	P63	BN63B6	260-261
8.6	1.8	47	119	1.4	0.6	70	3450	VF 49_70	V025 P63	V 0.25 C V 0.25 F	P63	BN63B6	260-261
10.1	2.1	43	109	1.5	0.6	60	3450	VF 49_60	V025 P63	V 0.25 C V 0.25 F	P63	BN63B6	260-261
10.1	2.1	44	111	1.1	0.5	60	2500	VF 44_60	V025 P63	V 0.25 C V 0.25 F	P63	BN63B6	258-259
13.1	2.7	37	94	1.3	0.5	46	2500	VF 44_46	V025 P63	V 0.25 C V 0.25 F	P63	BN63B6	258-259
13.4	2.8	36	92	2.1	0.9	45	3450	VF 49_45	V025 P63	V 0.25 C V 0.25 F	P63	BN63B6	260-261
16.8	3.5	31	79	2.5	1.0	36	3450	VF 49_36	V025 P63	V 0.25 C V 0.25 F	P63	BN63B6	260-261
17.3	3.6	30	78	1.7	0.7	35	2500	VF 44_35	V025 P63	V 0.25 C V 0.25 F	P63	BN63B6	258-259
21.6	4.5	25	65	3.3	1.3	28	3390	VF 49_28	V025 P63	V 0.25 C V 0.25 F	P63	BN63B6	260-261
21.6	4.5	26	66	2.0	0.8	28	2500	VF 44_28	V025 P63	V 0.25 C V 0.25 F	P63	BN63B6	258-259
25.2	5.2	24	60	3.0	1.2	24	3230	VF 49_24	V025 P63	V 0.25 C V 0.25 F	P63	BN63B6	260-261
30	6.3	20	53	2.3	0.9	20	2500	VF 44_20	V025 P63	V 0.25 C V 0.25 F	P63	BN63B6	258-259
34	6.9	19.0	48	3.8	1.5	18	2940	VF 49_18	V025 P63	V 0.25 C V 0.25 F	P63	BN63B6	260-261
43	8.9	15.0	39	4.9	2.0	14	2720	VF 49_14	V025 P63	V 0.25 C V 0.25 F	P63	BN63B6	260-261
43	8.9	15.0	39	3.1	1.3	14	2420	VF 44_14	V025 P63	V 0.25 C V 0.25 F	P63	BN63B6	258-259
60	12.5	11.0	30	3.7	1.5	10	2170	VF 44_10	V025 P63	V 0.25 C V 0.25 F	P63	BN63B6	258-259
86	17.9	8.0	21	5.1	2.1	7	1930	VF 44_7	V025 P63	V 0.25 C V 0.25 F	P63	BN63B6	258-259

## 0.18 kW

8.6	1.8	67	129	1.0	0.5	70	3450	VF 49_70	V025 P63	V 0.25 C V 0.25 F	P63	BN71A6R	260-261
10.1	2.1	61	118	1.1	0.6	60	3450	VF 49_60	V025 P63	V 0.25 C V 0.25 F	P63	BN71A6R	260-261
11.4	2.4	56	138	1.0	0.4	80	3300	VF 49_80	V025 P63	V 0.25 C V 0.25 F	P63	BN63B4	260-261
13.0	2.7	53	129	1.1	0.5	70	3300	VF 49_70	V025 P63	V 0.25 C V 0.25 F	P63	BN63B4	260-261
15.2	3.2	48	118	1.3	0.6	60	3300	VF 49_60	V025 P63	V 0.25 C V 0.25 F	P63	BN63B4	260-261
16.8	3.5	44	85	1.8	0.9	36	3450	VF 49_36	V025 P63	V 0.25 C V 0.25 F	P63	BN71A6R	260-261
19.8	4.1	41	101	1.2	0.5	46	1300	VF 44_46	V025 P63	V 0.25 C V 0.25 F	P63	BN63B4	258-259
20.2	4.2	40	99	1.8	0.8	45	3300	VF 49_45	V025 P63	V 0.25 C V 0.25 F	P63	BN63B4	260-261
21.6	4.5	36	71	2.3	1.2	28	3300	VF 49_28	V025 P63	V 0.25 C V 0.25 F	P63	BN71A6R	260-261
25.3	5.3	34	85	2.2	0.9	36	3150	VF 49_36	V025 P63	V 0.25 C V 0.25 F	P63	BN63B4	260-261
26.0	5.4	34	84	1.5	0.7	35	1300	VF 44_35	V025 P63	V 0.25 C V 0.25 F	P63	BN63B4	258-259



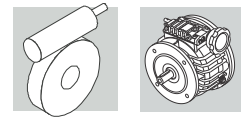

## 0.18 kW





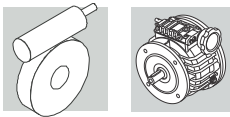

$n_2$ min <sup>-1</sup>	$n_2'$ min <sup>-1</sup>	M <sub>2</sub> Nm	M <sub>2'</sub> Nm	S	S'	i	R <sub>n2</sub> N	V	P(IEC)	C	F	IEC	
30	6.3	29	58	1.6	0.9	20	2500	VF 44_20	V025 P63	V 0.25 C V 0.25 F	P63	BN71A6R	258-259
33	6.8	28	71	2.9	1.2	28	2910	VF 49_28	V025 P63	V 0.25 C V 0.25 F	P63	BN63B4	260-261
33	6.8	28	72	1.7	0.8	28	1300	VF 44_28	V025 P63	V 0.25 C V 0.25 F	P63	BN63B4	258-259
38	7.9	26	65	2.7	1.1	24	2780	VF 49_24	V025 P63	V 0.25 C V 0.25 F	P63	BN63B4	260-261
43	8.9	22	43	2.2	1.2	14	2360	VF 44_14	V025 P63	V 0.25 C V 0.25 F	P63	BN71A6R	258-259
46	9.5	22	58	2.0	0.9	20	1300	VF 44_20	V025 P63	V 0.25 C V 0.25 F	P63	BN63B4	258-259
51	10.6	20	52	3.4	1.4	18	2450	VF 49_18	V025 P63	V 0.25 C V 0.25 F	P63	BN63B4	260-261
60	12.5	16.0	32	2.6	1.4	10	2120	VF 44_10	V025 P63	V 0.25 C V 0.25 F	P63	BN71A6R	258-259
65	13.6	16.0	42	4.3	1.9	14	2350	VF 49_14	V025 P63	V 0.25 C V 0.25 F	P63	BN63B4	260-261
65	13.6	16.0	43	2.4	1.2	14	2080	VF 44_14	V025 P63	V 0.25 C V 0.25 F	P63	BN63B4	258-259
86	17.9	12.0	23	3.6	1.9	7	1890	VF 44_7	V025 P63	V 0.25 C V 0.25 F	P63	BN71A6R	258-259
91	19.0	12.0	32	5.2	2.3	10	2110	VF 49_10	V025 P63	V 0.25 C V 0.25 F	P63	BN63B4	260-261
91	19.0	12.0	32	3.2	1.4	10	1870	VF 44_10	V025 P63	V 0.25 C V 0.25 F	P63	BN63B4	258-259
130	27.1	9.0	23	4.4	1.9	7	1660	VF 44_7	V025 P63	V 0.25 C V 0.25 F	P63	BN63B4	258-259

## 0.25 kW

6.6	1.3	150	352	1.1	0.5	100	6200	W 75_100	— P71	— V 0.5 F	P71	BN71B6	263
8.3	1.6	130	314	1.5	0.7	80	6200	W 75_80	— P71	— V 0.5 F	P71	BN71B6	263
8.3	1.6	125	294	1.0	0.5	80	5000	W 63_80	V05 P71	V 0.5 C V 0.5 F	P71	BN71B6	262
10.0	1.9	100	220	1.6	0.8	100	6200	W 75_100	— P71	— V 0.5 F	P71	BN71A4	263
10.0	1.9	92	205	1.3	0.6	100	5000	W 63_100	V05 P71	V 0.5 C V 0.5 F	P71	BN71A4	262
11.1	2.1	108	264	2.0	0.9	60	6200	W 75_60	— P71	— V 0.5 F	P71	BN71B6	263
12.5	2.4	86	196	2.3	1.1	80	6200	W 75_80	— P71	— V 0.5 F	P71	BN71A4	263
12.5	2.4	83	184	1.5	0.7	80	5000	W 63_80	V05 P71	V 0.5 C V 0.5 F	P71	BN71A4	262
13.0	2.7	63	129	1.0	0.5	70	3300	VF 49_70	V025 P63	V 0.25 C V 0.25 F	P63	BN63C4	260-261
14.7	2.8	85	209	1.8	0.8	45	5000	W 63_45	V05 P71	V 0.5 C V 0.5 F	P71	BN71B6	262
15.2	3.2	57	118	1.1	0.6	60	3300	VF 49_60	V025 P63	V 0.25 C V 0.25 F	P63	BN63C4	260-261
15.6	3.0	81	186	3.7	1.8	64	7000	W 86_64	— P71	— V 0.5 F	P71	BN71A4	264
16.7	3.2	72	165	3.0	1.4	60	6200	W 75_60	— P71	— V 0.5 F	P71	BN71A4	263
18.4	3.5	66	170	1.2	0.5	36	3270	VF 49_36	V05 P71	V 0.5 C V 0.5 F	P71	BN71B6	260-261
19.8	4.1	49	101	1.0	0.5	46	2300	VF 44_46	V025 P63	V 0.25 C V 0.25 F	P63	BN63C4	258-259
20.0	3.8	63	145	3.7	1.8	50	6200	W 75_50	— P71	— V 0.5 F	P71	BN71A4	263
20.2	4.2	48	99	1.5	0.8	45	3300	VF 49_45	V025 P63	V 0.25 C V 0.25 F	P63	BN63C4	260-261
22.2	4.2	53	124	1.3	0.6	45	3150	VF49_45	V05 P71	V 0.5 C V 0.5 F	P71	BN71A4	260-261







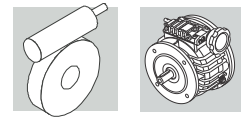

## 0.25 kW

$n_2$ min <sup>-1</sup>	$n_2'$ min <sup>-1</sup>	$M_2$ Nm	$M_2'$ Nm	S	S'	i	$R_{n2}$ N	 V	 P(IEC)	 C	 F	 IEC	
22.2	4.2	57	131	2.7	1.3	45	5000	W 63_45	V05 P71	V 0.5 C V 0.5 F	P71	BN71A4	262
23.7	4.5	55	141	1.6	0.6	28	3040	VF49_28	V05 P71	V 0.5 C V 0.5 F	P71	BN71B6	260-261
25.3	5.3	41	85	1.8	0.9	36	3100	VF 49_36	V025 P63	V 0.25 C V 0.25 F	P63	BN63C4	260-261
26.0	5.4	40	84	1.2	0.7	35	2300	VF 44_35	V025 P63	V 0.25 C V 0.25 F	P63	BN63C4	258-259
26.3	5.0	50	116	3.3	1.6	38	4790	W 63_38	V05 P71	V 0.5 C V 0.5 F	P71	BN71A4	262
27.8	5.3	45	106	1.7	0.8	36	2960	VF49_36	V05 P71	V 0.5 C V 0.5 F	P71	BN71A4	260-261
30	6.3	38	76	1.1	0.9	60	2970	VF49_60	V025 P63	V 0.25 C V 0.25 F	P63	BN63B2	2260-261
33	6.8	34	71	2.4	1.2	28	2870	VF 49_28	V025 P63	V 0.25 C V 0.25 F	P63	BN63C4	260-261
33	6.8	34	72	1.5	0.8	28	2300	VF 44_28	V025 P63	V 0.25 C V 0.25 F	P63	BN63C4	258-259
33	6.3	42	96	4.0	2.0	30	4460	W 63_30	V05 P71	V 0.5 C V 0.5 F	P71	BN71A4	262
35	6.6	44	111	3.6	1.6	19	4360	W 63_19	V05 P71	V 0.5 C V 0.5 F	P71	BN71B6	262
36	6.8	38	88	2.2	1.0	28	2740	VF 49_28	V05 P71	V 0.5 C V 0.5 F	P71	BN71A4	260-261
38	7.9	31	65	2.2	1.1	24	2740	VF 49_24	V025 P63	V 0.25 C V 0.25 F	P63	BN63C4	260-261
40	8.4	31	64	1.6	1.2	45	2710	VF 49_45	V025 P63	V 0.25 C V 0.25 F	P63	BN63B2	260-261
42	7.9	36	84	4.6	2.2	24	4160	W 63_24	V05 P71	V 0.5 C V 0.5 F	P71	BN71A4	262
42	7.9	34	82	2.0	0.9	24	2620	VF 49_24	V05 P71	V 0.5 C V 0.5 F	P71	BN71A4	260-261
44	8.3	36	91	4.4	2.0	15	4060	W 63_15	V05 P71	V 0.5 C V 0.5 F	P71	BN71B6	262
46	9.5	27	58	1.7	0.9	20	2290	VF 44_20	V025 P63	V 0.25 C V 0.25 F	P63	BN63C4	258-259
47	8.9	32	84	2.3	0.9	14	2490	VF 49_14	V05 P71	V 0.5 C V 0.5 F	P71	BN71B6	260-261
51	10.6	24	52	2.8	1.4	18	2510	VF 49_18	V025 P63	V 0.25 C V 0.25 F	P63	BN63C4	260-261
52	10.9	26	55	1.1	1.0	35	2230	VF 44_35	V025 P63	V 0.25 C V 0.25 F	P63	BN63B2	258-259
53	10.0	30	69	5.4	2.6	19	3870	W 63_19	V05 P71	V 0.5 C V 0.5 F	P71	BN71A4	262
56	10.6	27	65	2.5	1.1	18	2400	VF 49_18	V05 P71	V 0.5 C V 0.5 F	P71	BN71A4	260-261
65	13.6	21	46	2.7	1.9	28	2340	VF 49_28	V025 P63	V 0.25 C V 0.25 F	P63	BN63B2	260-261
65	13.6	20	42	3.6	1.9	14	2320	VF 49_14	V025 P63	V 0.25 C V 0.25 F	P63	BN63C4	260-261
65	13.6	21	47	1.4	1.2	28	2080	VF 44_28	V025 P63	V 0.25 C V 0.25 F	P63	BN63B2	258-259
65	13.6	20	43	2.0	1.2	14	2050	VF 44_14	V025 P63	V 0.25 C V 0.25 F	P63	BN63C4	258-259
71	13.6	22	53	3.3	1.5	14	2230	VF 49_14	V05 P71	V 0.5 C V 0.5 F	P71	BN71A4	260-261
76	15.8	19.0	42	2.5	1.7	24	2230	VF 49_24	V025 P63	V 0.25 C V 0.25 F	P63	BN63B2	260-261
91	19.0	16.0	37	1.8	1.3	20	1870	VF 44_20	V025 P63	V 0.25 C V 0.25 F	P63	BN63B2	258-259
91	19.0	15.0	32	4.3	2.3	10	2090	VF 49_10	V025 P63	V 0.25 C V 0.25 F	P63	BN63C4	260-261
91	19.0	15.0	32	2.6	1.4	10	1840	VF 44_10	V025 P63	V 0.25 C V 0.25 F	P63	BN63C4	258-259
100	19.0	16.0	40	3.9	1.9	10	2000	VF 49_10	V05 P71	V 0.5 C V 0.5 F	P71	BN71A4	260-261
101	21.1	15.0	34	3.0	2.2	18	2040	VF 49_18	V025 P63	V 0.25 C V 0.25 F	P63	BN63B2	260-261
130	27.1	12.0	28	1.9	1.8	14	1670	VF 44_14	V025 P63	V 0.25 C V 0.25 F	P63	BN63B2	258-259



## 0.25 kW





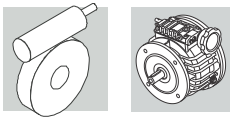

$n_2$ min <sup>-1</sup>	$n_2'$ min <sup>-1</sup>	$M_2$ Nm	$M_2'$ Nm	S	S'	i	R <sub>n2</sub> N	 V	 P(IEC)	 C	 F	 IEC	
130	27.1	11.0	23	3.6	1.9	7	1640	VF 44_7	V025 P63	V 0.25 C VBG 0.25 F	P63	BN63C4	258-259
143	27.1	12.0	29	5.1	2.5	7	1790	VF 49_7	V05 P71	V 0.5 C V 0.5 F	P71	BN71A4	260-261
182	38	9.0	21	2.5	2.2	10	1500	VF 44_10	V025 P63	V 0.25 C V 0.25 F	P63	BN63B2	258-259
260	54	6.0	15.0	3.6	3.0	7	1330	VF 44_7	V025 P63	V 0.25 C V 0.25 F	P63	BN63B2	258-259

## 0.37 kW

8.3	1.6	173	314	1.1	0.7	80	6200	W 75_80	— P71	— V 0.5 F	P71	BN71C6	263
10.0	1.9	150	352	1.1	0.5	100	6200	W 75_100	— P71	— V 0.5 F	P71	BN71B4	263
10.4	2.0	143	261	0.9	0.6	64	5000	W63_64	V05 P71	V 0.5 C V 0.5 F	P71	BN71C6	262
12.5	2.4	130	314	1.5	0.7	80	6200	W 75_80	— P71	— V 0.5 F	P71	BN71B4	263
12.5	2.4	125	294	1.0	0.5	80	5000	W 63_80	V05 P71	V 0.5 C V 0.5 F	P71	BN71B4	262
14.7	2.8	113	209	1.4	0.8	45	5000	W 63_45	V05 P71	V 0.5 C V 0.5 F	P71	BN71C6	262
15.6	3.0	108	261	1.3	0.6	64	5000	W 63_64	V05 P71	V 0.5 C V 0.5 F	P71	BN71B4	262
16.7	3.2	108	264	2.0	0.9	60	6200	W 75_60	— P71	— V 0.5 F	P71	BN71B4	263
17.4	3.3	100	185	1.6	1.0	38	5000	W 63_38	V05 P71	V 0.5 C V 0.5 F	P71	BN71C6	262
20.0	3.8	95	232	2.5	1.1	50	6200	W 75_50	— P71	— V 0.5 F	P71	BN71B4	263
22.2	4.2	85	209	1.8	0.8	45	4850	W 63_45	V05 P71	V 0.5 C V 0.5 F	P71	BN71B4	262
23.7	4.5	73	141	1.2	0.6	28	2900	VF 49_28	V05 P71	V 0.5 C V 0.5 F	P71	BN71C6	260-261
26.3	5.0	75	185	2.2	1.0	38	4620	W 63_38	V05 P71	V 0.5 C V 0.5 F	P71	BN71B4	262
27.6	5.2	72	134	2.3	1.4	24	4550	W 63_24	V05 P71	V 0.5 C V 0.5 F	P71	BN71C6	262
27.8	5.3	68	170	1.1	0.5	36	2790	VF 49_36	V05 P71	V 0.5 C V 0.5 F	P71	BN71B4	260-261
33	6.3	63	154	2.7	1.2	30	4310	W 63_30	V05 P71	V 0.5 C V 0.5 F	P71	BN71B4	262
35	6.6	59	111	2.7	1.6	19	4250	W 63_19	V05 P71	V 0.5 C V 0.5 F	P71	BN71C6	262
36	6.8	56	141	1.5	0.6	28	2600	VF 49_28	V05 P71	V 0.5 C V 0.5 F	P71	BN71B4	260-261
40	8.4	47	99	1.1	0.8	45	2610	VF 49_45	V025 P63	V 0.25 C V 0.25 F	P63	BN63C2	260-261
42	7.9	54	134	3.1	1.4	24	4030	W 63_24	V05 P71	V 0.5 C V 0.5 F	P71	BN71B4	262
42	7.9	51	131	1.3	0.6	24	2490	VF 49_24	V05 P71	V 0.5 C V 0.5 F	P71	BN71B4	260-261
44	8.3	48	91	3.3	2.0	15	3970	W 63_15	V05 P71	V 0.5 C V 0.5 F	P71	BN71C6	262
51	10.6	39	85	1.3	0.9	36	2450	VF 49_36	V025 P63	V 0.25 C V 0.25 F	P63	BN63C2	260-261
53	10.0	44	111	3.6	1.6	19	3760	W 63_19	V05 P71	V 0.5 C V 0.5 F	P71	BN71B4	262
56	10.6	41	104	1.7	0.7	18	2290	VF 49_18	V05 P71	V 0.5 C V 0.5 F	P71	BN71B4	260-261
65	13.6	32	71	1.8	1.2	28	2270	VF 49_28	V025 P63	V 0.25 C V 0.25 F	P63	BN63C2	260-261



## 0.37 kW

$n_2$ min <sup>-1</sup>	$n_2'$ min <sup>-1</sup>	$M_2$ Nm	$M_2'$ Nm	S	S'	i	$R_{n2}$ N	 $V$  P(IEC)	 $C$  $F$	 IEC			
67	12.7	36	91	4.4	2.0	15	3500	W 63_15	V05 P71	V 0.5 C V 0.5 F	P71	BN71B4	262
71	13.6	33	84	2.2	0.9	14	2140	VF 49_14	V05 P71	V 0.5 C V 0.5 F	P71	BN71B4	260-261
76	15.8	28	65	1.7	1.1	24	2160	VF 49_24	V025 P63	V 0.25 C V 0.25 F	P63	BN63C2	260-261
91	19.0	24	58	1.2	0.9	20	1810	VF 44_20	V025 P63	V 0.25 C V 0.25 F	P63	BN63C2	258-259
95	17.9	24	46	2.8	1.6	7	1950	VF 49_7	V05 P71	V 0.5 C V 0.5 F	P71	BN71C6	260-261
100	19.0	25	65	6.0	2.5	10	5000	W 63_10	V05 P71	V 0.5 C V 0.5 F	P71	BN71B4	262
100	19.0	25	64	2.6	1.2	10	1930	VF 49_10	V05 P71	V 0.5 C V 0.5 F	P71	BN71B4	260-261
101	21.1	22	52	2.0	1.4	18	1980	VF 49_18	V025 P63	V 0.25 C V 0.25 F	P63	BN63C2	260-261
130	27.1	18.0	42	2.8	1.9	14	1840	VF 49_14	V025 P63	V 0.25 C V 0.25 F	P63	BN63C2	260-261
130	27.1	18.0	43	1.2	1.2	14	1620	VF 44_14	V025 P63	V 0.25 C V 0.25 F	P63	BN63C2	224-226
143	27.1	18.0	46	3.4	1.6	7	1730	VF 49_7	V05 P71	V 0.5 C V 0.5 F	P71	BN71B4	260-261
182	38	13.0	32	3.4	2.3	10	1650	VF 49_10	V025 P63	V 0.25 C V 0.25 F	P63	BN63C2	260-261
260	54	9.0	23	2.4	1.9	7	1300	VF 44_7	V025 P63	V 0.25 C V 0.25 F	P63	BN63C2	260-261

## 0.55 kW

6.6	1.3	342	816	1.4	0.7	100	8000	W 110_100	— P80	— V 1 F	P80	BN80B6	265
8.3	1.6	293	717	1.7	0.8	80	8000	W 110_80	— P80	— V 1 F	P80	BN80B6	265
8.3	1.6	283	678	1.0	0.4	80	7000	W 86_80	V1 P80	V 1 C V 1 F	P80	BN80B6	264
10.0	1.9	257	612	1.9	0.9	100	8000	W 110_100	— P80	— V 1 F	P80	BN80A4	265
10.0	1.9	248	392	1.0	0.7	100	7000	W 86_100	— P71	— V 0.5 F	P80	BN80A4	264
10.4	2.0	250	614	2.3	1.0	64	8000	W 110_64	— P80	— V 1 F	P80	BN80B6	265
10.4	2.0	242	594	1.2	0.6	64	7000	W 86_64	V1 P80	V 1 C V 1 F	P80	BN80B6	264
11.8	2.2	228	564	2.8	1.3	56	8000	W 110_56	— P80	— V 1 F	P80	BN80B6	265
11.8	2.2	222	269	1.5	1.3	56	7000	W 86_56	— P71	— V 0.5 F	P80	BN80B6	264
12.5	2.4	212	509	1.3	0.6	80	7000	W 86_80	V1 P80	V 1 C V 1 F	P80	BN80A4	264
12.5	2.4	194	470	1.0	0.5	80	6200	W 75_80	V1 P80	V 1 C V 1 F	P80	BN80A4	263
14.4	2.7	196	486	3.3	1.5	46	8000	W 110_46	— P80	— V 1 F	P80	BN80B6	265
15.6	3.0	181	445	1.7	0.7	64	7000	W 86_64	V1 P80	V 1 C V 1 F	P80	BN80A4	264
16.6	3.1	163	403	1.7	0.8	40	6200	W 75_40	V1 P80	V 1 C V 1 F	P80	BN80B6	263
16.7	3.2	162	396	1.3	0.6	60	6200	W 75_60	V1 P80	V 1 C V 1 F	P80	BN80A4	263
17.9	3.4	166	403	2.0	0.9	56	7000	W 86_56	V1 P80	V 1 C V 1 F	P80	BN80A4	264
20.0	3.8	142	348	1.7	0.7	50	6200	W 75_50	V1 P80	V 1 C V 1 F	P80	BN80A4	263