











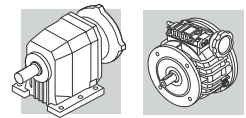

4 kW

n_2 min ⁻¹	n_2' min ⁻¹	M ₂ Nm	M _{2'} Nm	S	S'	i	R _{n2} N					IEC 	
9.4	1.8	2819	5639	1.4	0.7	70.5	35000	C803_70.5	— P132	— V 10 F	P132	BN132MA6	206
10.3	2.0	2899	6522	1.4	0.6	97.4	35000	C803_97.4	— P112	— V 5.5 F	P112	BN112M4	206
10.4	2.0	2863	6442	2.5	1.1	96.2	60000	C903_96.2	— P112	— V 5.5 F	P112	BN112M4	207
10.6	2.0	2499	4999	1.6	0.8	62.5	35000	C803_62.5	— P132	— V 10 F	P132	BN132MA6	206
11.2	2.1	2658	5980	1.5	0.7	89.3	35000	C803_89.3	— P112	— V 5.5 F	P112	BN112M4	206
11.3	2.2	2625	5906	2.7	1.2	88.2	60000	C903_88.2	— P112	— V 5.5 F	P112	BN112M4	207
11.6	2.2	2291	4583	1.7	0.9	57.3	35000	C803_57.3	— P132	— V 10 F	P132	BN132MA6	206
12.3	2.3	2417	5437	3.0	1.3	81.2	60000	C903_81.2	— P112	— V 5.5 F	P112	BN112M4	207
13.0	2.5	2289	5149	1.7	0.8	76.9	35000	C803_76.9	— P112	— V 5.5 F	P112	BN112M4	206
13.4	2.6	2214	4982	3.2	1.4	74.4	60000	C903_74.4	— P112	— V 5.5 F	P112	BN112M4	207
14.0	2.7	2122	4774	1.1	0.5	71.3	25000	C703_71.3	V55 P112	V 5.5 C V 5.5 F	P112	BN112M4	204-205
14.2	2.7	2098	4721	1.9	0.8	70.5	35000	C803_70.5	— P112	— V 5.5 F	P112	BN112M4	206
15.2	2.9	1961	4413	1.2	0.5	65.9	25000	C703_65.9	V55 P112	V 5.5 C V 5.5 F	P112	BN112M4	204-205
16.0	3.0	1860	4185	2.2	1.0	62.5	35000	C803_62.5	— P112	— V 5.5 F	P112	BN112M4	206
16.1	3.0	1652	3303	1.4	0.7	41.3	25000	C703_41.3	— P132	— V 10 F	P132	BN132MA6	204-205
17.0	3.2	1597	3194	2.0	1.0	39.1	35000	C802_39.1	— P132	— V 10 F	P132	BN132MA6	206
17.5	3.3	1705	3837	2.3	1.0	57.3	35000	C803_57.3	— P112	— V 5.5 F	P112	BN112M4	206
17.7	3.4	1681	3783	1.4	0.6	56.5	25000	C703_56.5	V55 P112	V 5.5 C V 5.5 F	P112	BN112M4	204-205
19.1	3.6	1417	2835	1.5	0.7	34.7	25000	C702_34.7	— P132	— V 10 F	P132	BN132MA6	204-205
19.2	3.6	1553	3495	1.5	0.7	52.2	25000	C703_52.2	V55 P112	V 5.5 C V 5.5 F	P112	BN112M4	204-205
21.1	4.0	1411	3174	2.8	1.3	47.4	35000	C803_47.4	— P112	— V 5.5 F	P112	BN112M4	206
22.4	4.3	1330	2993	1.7	0.8	44.7	25000	C703_44.7	V55 P112	V 5.5 C V 5.5 F	P112	BN112M4	204-205
23.0	4.4	1295	2913	3.1	1.4	43.5	35000	C803_43.5	— P112	— V 5.5 F	P112	BN112M4	206
23.9	4.5	1132	2263	1.9	0.9	27.7	25000	C702_27.7	— P132	— V 10 F	P132	BN132MA6	204-205
24.2	4.6	1229	2765	1.9	0.8	41.3	25000	C703_41.3	V55 P112	V 5.5 C V 5.5 F	P112	BN112M4	204-205
25.6	4.9	1189	2674	2.7	1.2	39.1	35000	C802_39.1	— P112	— V 5.5 F	P112	BN112M4	206
27.6	5.2	980	1961	3.6	1.8	24.0	35000	C802_24.0	— P132	— V 10 F	P132	BN132MA6	206
28.8	5.5	1055	2373	2.0	0.9	34.7	25000	C702_34.7	V55 P112	V 5.5 C V 5.5 F	P112	BN112M4	204-205
29.0	5.5	935	1871	2.2	1.1	22.9	25000	C702_22.9	— P132	— V 10 F	P132	BN132MA6	204-205
32	6.1	952	2141	3.9	1.7	31.3	35000	C802_31.3	— P112	— V 5.5 F	P112	BN112M4	206
34	6.4	1173	2160	1.2	0.6	19.6	16000	C612_19.6	V10 P132	V 10 C V 10 F	P132	BN132MA6	202-203
34	6.5	788	1577	2.7	1.3	19.3	25000	C702_19.3	— P132	— V 10 F	P132	BN132MA6	204-205
36	6.9	842	1895	2.5	1.1	27.7	25000	C702_27.7	V55 P112	V 5.5 C V 5.5 F	P112	BN112M4	204-205
39	7.3	787	1772	4.7	2.1	25.9	35000	C802_25.9	— P112	— V 5.5 F	P112	BN112M4	206
42	7.9	952	1752	1.4	0.8	15.9	16000	C612_15.9	V10 P132	V 10 C V 10 F	P132	BN132MA6	202-203



4 kW





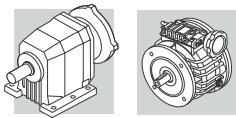

n_2 min ⁻¹	n_2' min ⁻¹	M_2 Nm	M_2' Nm	S	S'	i	R_{n2} N					IEC 	
43	8.2	625	1250	3.4	1.7	15.3	25000	C702_15.3	—	—	P132	BN132MA6	204-205
44	8.3	696	1566	3.0	1.3	22.9	25000	C702_22.9	V55 P112	V 5.5 C V 5.5 F	P112	BN112M4	204-205
47	8.9	576	1152	3.7	1.9	14.1	25000	C702_14.1	—	—	P132	BN132MA6	204-205
51	9.7	596	134	2.3	1.0	19.6	15300	C612_19.6	V55 P112	V 5.5 C V 5.5 F	P112	BN112M4	202-203
52	9.8	587	1320	3.6	1.6	19.3	25000	C702_19.3	V55 P112	V 5.5 C V 5.5 F	P112	BN112M4	204-205
55	10.3	724	1333	1.9	1.0	12.1	15200	C612_12.1	V10 P132	V 10 C V 10 F	P132	BN132MA6	202-203
60	11.4	505	1135	1.6	0.7	16.6	10000	C512_16.6	V55 P112	V 5.5 C V 5.5 F	P112	BN112M4	200-201
61	11.5	652	1201	2.1	1.1	10.9	14800	C612_10.9	V10 P132	V 10 C V 10 F	P132	BN132MA6	202-203
68	12.8	587	1080	2.3	1.3	9.8	14400	C612_9.8	V10 P132	V 10 C V 10 F	P132	BN132MA6	202-203
75	14.2	527	970	2.6	1.4	8.8	13900	C612_8.8	V10 P132	V 10 C V 10 F	P132	BN132MA6	202-203
76	14.5	398	896	2.0	0.9	13.1	9900	C512_13.1	V55 P112	V 5.5 C V 5.5 F	P112	BN112M4	200-201
88	16.7	449	827	3.0	1.6	7.5	13300	C612_7.5	V10 P132	V 10 C V 10 F	P132	BN132MA6	202-203
99	18.7	401	738	3.4	1.8	6.7	12900	C612_6.7	V10 P132	V 10 C V 10 F	P132	BN132MA6	202-203
102	19.4	298	670	2.7	1.2	9.8	9200	C512_9.8	V55 P112	V 5.5 C V 5.5 F	P112	BN112M4	200-201
114	21.6	268	602	3.0	1.3	8.8	8960	C512_8.8	V55 P112	V 5.5 C V 5.5 F	P112	BN112M4	200-201
128	24.4	237	534	3.1	1.5	7.8	8660	C512_7.8	V55 P112	V 5.5 C V 5.5 F	P112	BN112M4	200-201
143	27.1	213	479	3.4	1.7	7.0	8420	C512_7.0	V55 P112	V 5.5 C V 5.5 F	P112	BN112M4	200-201
179	34	170	383	2.6	1.1	5.6	7790	C512_5.6	V55 P112	V 5.5 C V 5.5 F	P112	BN112M4	200-201
179	34	221	408	2.8	1.6	3.7	10700	C612_3.7	V10 P132	V 10 C V 10 F	P132	BN132MA6	202-203
222	42	137	308	3.2	1.4	4.5	7310	C512_4.5	V55 P112	V 5.5 C V 5.5 F	P112	BN112M4	200-201
237	45	168	309	3.4	2.2	2.8	10000	C612_2.8	V10 P132	V 10 C V 10 F	P132	BN132MA6	202-203
270	51	112	253	5.6	2.6	3.7	9500	C612_3.7	V55 P112	V 5.5 C V 5.5 F	P112	BN112M4	202-203
303	58	100	226	4.2	1.9	3.3	6710	C512_3.3	V55 P112	V 5.5 C V 5.5 F	P112	BN112M4	200-201
357	68	85	192	6.6	3.5	2.8	9000	C612_2.8	V55 P112	V 5.5 C V 5.5 F	P112	BN112M4	202-203
385	73	79	178	5.1	2.2	2.6	6280	C512_2.6	V55 P112	V 5.5 C V 5.5 F	P112	BN112M4	200-201

5.5 kW

5.7	1.1	6837	12590	1.1	0.6	116.7	60000	C903_116.7	—	—	P132	BN132MB6	207
5.8	1.1	6882	13765	1.0	0.5	172.1	60000	C903_172.1	—	—	P132	BN132S4	207
6.3	1.2	6310	12621	1.1	0.6	157.8	60000	C903_157.8	—	—	P132	BN132S4	207
6.8	1.3	5851	11701	1.2	0.6	146.3	60000	C903_146.3	—	—	P132	BN132S4	207
6.9	1.3	5636	10378	1.3	0.7	96.2	60000	C903_96.2	—	—	P132	BN132MB6	207
7.5	1.4	5363	10725	1.3	0.7	134.1	60000	C903_134.1	—	—	P132	BN132S4	207
8.6	1.6	4667	9334	1.5	0.8	116.7	60000	C903_116.7	—	—	P132	BN132S4	207



5.5 kW

n_2 min ⁻¹	n_2' min ⁻¹	M_2 Nm	M_2' Nm	S	S'	i	R_{n2} N					IEC 	
9.3	1.8	4279	8558	1.7	0.8	107.0	60000	C903_107.0	P132	V 10 F	P132	BN132S4	201
9.4	1.8	4131	7606	1.0	0.5	70.5	35000	C803_70.5	P132	V 10 F	P132	BN132MB6	206
10.3	2.0	3895	7790	1.0	0.5	97.4	35000	C803_97.4	P132	V 10 F	P132	BN132S4	206
10.4	2.0	3847	7694	1.9	0.9	96.2	60000	C903_96.2	P132	V 10 F	P132	BN132S4	207
10.6	2.0	3662	6743	1.1	0.6	62.5	35000	C803_62.5	P132	V 10 F	P132	BN132MB6	206
11.2	2.1	3571	7142	1.1	0.6	89.3	35000	C803_89.3	P132	V 10 F	P132	BN132S4	206
11.2	2.1	3469	6386	2.0	1.1	59.2	60000	C903_59.2	P132	V 10 F	P132	BN132MB6	207
11.3	2.2	3527	7054	2.0	1.0	88.2	60000	C903_88.2	P132	V 10 F	P132	BN132S4	207
12.3	2.3	3247	6494	2.2	1.1	81.2	60000	C903_81.2	P132	V 10 F	P132	BN132S4	207
13.0	2.5	3075	6150	1.3	0.7	76.9	35000	C803_76.9	P132	V 10 F	P132	BN132S4	206
13.4	2.6	2975	5951	2.4	1.2	74.4	60000	C903_74.4	P132	V 10 F	P132	BN132S4	207
14.2	2.7	2819	5639	1.4	0.7	70.5	35000	C803_70.5	P132	V 10 F	P132	BN132S4	206
15.5	2.9	2583	5167	2.8	1.4	64.6	60000	C903_64.6	P132	V 10 F	P132	BN132S4	207
16.0	3.0	2499	4999	1.6	0.8	62.5	35000	C803_62.5	P132	V 10 F	P132	BN132S4	206
16.1	3.0	2420	4455	1.0	0.5	41.3	25000	C703_41.3	P132	V 10 F	P132	BN132MB6	204-205
16.9	3.2	2367	4735	3.0	1.5	59.2	60000	C903_59.2	P132	V 10 F	P132	BN132S4	207
17.0	3.2	2340	4309	1.4	0.7	39.1	35000	C802_39.1	P132	V 10 F	P132	BN132MB6	206
17.5	3.3	2291	4583	1.7	0.9	57.3	35000	C803_57.3	P132	V 10 F	P132	BN132S4	206
18.2	3.5	2195	4391	3.3	1.6	54.9	60000	C903_54.9	P132	V 10 F	P132	BN132S4	207
18.9	3.6	2101	3868	2.6	1.4	35.1	35000	C902_35.1	P132	V 10 F	P132	BN132MB6	207
19.1	3.6	2077	3824	1.0	0.5	34.7	25000	C702_34.7	P132	V 10 F	P132	BN132MB6	204-205
21.1	4.0	1896	3791	2.1	1.1	47.4	35000	C803_47.4	P132	V 10 F	P132	BN132S4	206
23.0	4.4	1740	3479	2.3	1.1	43.5	35000	C803_43.5	P132	V 10 F	P132	BN132S4	206
23.3	4.4	1720	3439	4.2	2.1	43.0	57000	C903_43.0	P132	V 10 F	P132	BN132S4	207
23.9	4.5	1658	3053	1.3	0.7	27.7	25000	C702_27.7	P132	V 10 F	P132	BN132MB6	204-205
24.2	4.6	1652	3303	1.4	0.7	41.3	25000	C703_41.3	P132	V 10 F	P132	BN132S4	204-205
25.4	4.8	1576	3151	4.5	2.3	39.4	55900	C903_39.4	P132	V 10 F	P132	BN132S4	207
25.6	4.9	1597	3194	2.0	1.0	39.1	35000	C802_39.1	P132	V 10 F	P132	BN132S4	206
27.6	5.2	1436	2645	2.5	1.3	24.0	35000	C802_24.0	P132	V 10 F	P132	BN132MB6	206
28.8	5.5	1417	2835	1.5	0.7	34.7	25000	C702_34.7	P132	V 10 F	P132	BN132S4	204-205
29.0	5.5	1371	2524	1.5	0.8	22.9	25000	C702_22.9	P132	V 10 F	P132	BN132MB6	204-205
32	6.1	1279	2557	2.9	1.4	31.3	35000	C802_31.3	P132	V 10 F	P132	BN132S4	206
34	6.5	1155	2127	1.8	1.0	19.3	25000	C702_19.3	P132	V 10 F	P132	BN132MB6	204-205
34	6.5	1176	2351	1.4	0.7	29.4	15800	C613_29.4	V10 P132	V 10 C V 10 F	P132	BN132S4	202-203
36	6.9	1132	2263	1.9	0.9	27.7	25000	C702_27..7	P132	V 10 F	P132	BN132S4	204-205
37	6.9	1083	1995	3.4	1.9	18.1	35000	C802_18.1	P132	V 10 F	P132	BN132MB6	206

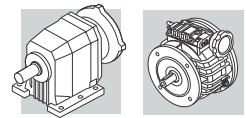

5.5 kW





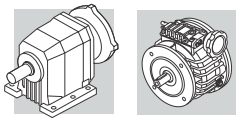

n_{2-1} min ⁻¹	$n_{2'}$ min ⁻¹	M_2 Nm	$M_{2'}$ Nm	S	S'	i	R_{n2} N					IEC	
39	7.3	1058	2116	3.5	1.7	25.9	35000	C802_25.9	— P132	— V 10 F	P132	BN132S4	206
40	7.5	999	1840	2.1	1.1	16.7	25000	C702_16.7	— P132	— V 10 F	P132	BN132MB6	204-205
40	7.7	1013	2026	1.3	0.7	24.8	15300	C612_24.8	V10 P132	V 10 C V 10 F	P132	BN132S4	202-203
42	7.9	980	1961	3.6	1.8	24.0	35000	C802_24.0	— P132	— V 10 F	P132	BN132S4	206
44	8.3	935	1871	2.2	1.1	22.9	25000	C702_22.9	— P132	— V 10 F	P132	BN132S4	204-205
45	8.6	907	1814	4.1	2.0	22.2	35000	C802_22.2	— P132	— V 10 F	P132	BN132S4	206
46	8.7	856	1576	1.6	0.9	14.3	14900	C612_14.3	V10 P132	V 10 C V 10 F	P132	BN132MB6	202-203
47	8.9	844	1554	2.5	1.4	14.1	25000	C702_14.1	— P132	— V 10 F	P132	BN132MB6	204-205
52	9.8	788	1577	2.7	1.3	19.3	25000	C702_19.3	— P132	— V 10 F	P132	BN132S4	204-205
56	10.7	723	1446	1.9	0.9	17.7	14200	C612_17.7	V10 P132	V 10 C V 10 F	P132	BN132S4	202-203
63	11.9	650	1299	2.1	1.0	15.9	13900	C612_15.9	V10 P132	V 10 C V 10 F	P132	BN132S4	202-203
65	12.4	625	1250	3.4	1.7	15.3	23750	C702_15.3	— P132	— V 10 F	P132	BN132S4	204-205
71	13.5	576	1152	3.7	1.9	14.1	23550	C702_14.1	— P132	— V 10 F	P132	BN132S4	204-205
77	14.6	531	1062	4.0	2.0	13.0	22560	C702_13.0	— P132	— V 10 F	P132	BN132S4	204-205
83	15.7	494	989	2.7	1.4	12.1	13000	C612_12.1	V10 P132	V 10 C V 10 F	P132	BN132S4	202-203
89	17.0	458	915	4.7	2.3	11.2	22100	C702_11.2	— P132	— V 10 F	P132	BN132S4	204-205
102	19.4	400	801	3.4	1.7	9.8	12400	C612_9.8	V10 P132	V 10 C V 10 F	P132	BN132S4	202-203
114	21.6	359	719	3.8	1.9	8.8	12000	C612_8.8	V10 P132	V 10 C V 10 F	P132	BN132S4	202-203
133	25.3	306	613	4.4	2.2	7.5	11500	C612_7.5	V10 P132	V 10 C V 10 F	P132	BN132S4	202-203
144	27.2	275	507	2.4	1.3	4.6	11100	C612_4.6	V10 P132	V 10 C V 10 F	P132	BN132MB6	202-203
149	28.4	274	547	4.9	2.5	6.7	11100	C612_6.7	V10 P132	V 10 C V 10 F	P132	BN132S4	202-203
167	32	245	490	2.7	1.4	6.0	10600	C612_6.0	V10 P132	V 10 C V 10 F	P132	BN132S4	202-203
217	41	188	376	3.5	1.8	4.6	9800	C612_4.6	V10 P132	V 10 C V 10 F	P132	BN132S4	202-203
270	51	151	302	4.1	2.2	3.7	9300	C612_3.7	V10 P132	V 10 C V 10 F	P132	BN132S4	202-203
357	68	114	229	4.9	2.9	2.8	8800	C612_2.8	V10 P132	V 10 C V 10 F	P132	BN132S4	202-203

7.5 kW

6.6	1.3	8113	16225	1.5	0.7	150.4	85000	C1003_150.4	— P132	— V 10 F	P132	BN132S4	208
7.2	1.4	7535	15071	1.5	0.7	139.7	85000	C1003_139.7	— P132	— V 10 F	P132	BN132S4	208
8.3	1.6	6500	13000	1.8	0.9	120.5	85000	C1003_120.5	— P132	— V 10 F	P132	BN132S4	208
8.9	1.7	6036	12072	2.0	1.0	111.9	85000	C1003_111.9	— P132	— V 10 F	P132	BN132S4	208
9.3	1.8	5772	11543	1.2	0.6	107.0	60000	C903_107.0	— P132	— V 10 F	P132	BN132S4	207
10.0	1.9	5383	10766	2.2	1.1	99.8	85000	C1003_99.8	— P132	— V 10 F	P132	BN132S4	208
10.4	2.0	5189	10378	1.4	0.7	96.2	60000	C903_96.2	— P132	— V 10 F	P132	BN132S4	207







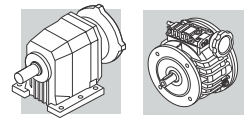

7.5 kW

n_2 min ⁻¹	n_2' min ⁻¹	M ₂ Nm	M _{2'} Nm	S	S'	i	R _{n2} N					IEC 	
10.8	2.0	5000	10000	2.4	1.2	92.7	85000	C1003_92.7	—	—	P132	BN132S4	208
11.3	2.2	4758	9515	1.5	0.7	88.2	60000	C903_88.2	—	—	P132	BN132S4	207
12.3	2.3	4380	8760	1.6	0.8	81.2	60000	C903_81.2	—	—	P132	BN132S4	207
13.0	2.5	4148	8296	1.0	0.5	76.9	35000	C803_76.9	—	—	P132	BN132S4	206
13.4	2.6	4013	8026	1.8	0.9	74.4	60000	C903_74.4	—	—	P132	BN132S4	207
14.2	2.7	3803	7606	1.1	0.5	70.5	35000	C803_70.5	—	—	P132	BN132S4	206
14.4	2.7	3743	7487	3.2	1.6	69.4	85000	C1003_69.4	—	—	P132	BN132S4	208
15.5	2.9	3485	6969	2.1	1.0	64.6	59510	C903_64.6	—	—	P132	BN132S4	207
15.5	2.9	3479	6958	3.4	1.7	64.5	85000	C1003_64.5	—	—	P132	BN132S4	208
16.0	3.0	3371	6743	1.2	0.6	62.5	35000	C803_62.5	—	—	P132	BN132S4	206
16.9	3.2	3193	6386	2.2	1.1	59.2	58610	C903_59.2	—	—	P132	BN132S4	207
17.4	3.3	3096	6192	3.9	1.9	57.4	85000	C1003_57.4	—	—	P132	BN132S4	208
17.5	3.3	3091	6182	1.3	0.6	57.3	35000	C803_57.3	—	—	P132	BN132S4	207
18.2	3.5	2961	5923	2.4	1.2	54.9	57800	C903_54.9	—	—	P132	BN132S4	207
18.8	3.6	2875	5750	4.2	2.1	53.3	85000	C1003_53.3	—	—	P132	BN132S4	208
19.9	3.8	2713	5426	2.6	1.3	50.3	56840	C903_50.3	—	—	P132	BN132S4	207
21.1	4.0	2557	5114	1.6	0.8	47.4	35000	C803_47.4	—	—	P132	BN132S4	206
23.0	4.4	2346	4693	1.7	0.9	43.5	35000	C803_43.5	—	—	P132	BN132S4	206
24.2	4.6	2228	4455	1.0	0.5	41.3	25000	C703_41.3	—	—	P132	BN132S4	204-205
25.6	4.9	2154	4309	1.5	0.7	39.1	35000	C802_39.1	—	—	P132	BN132S4	206
28.5	5.4	1934	3868	2.8	1.4	35.1	52610	C902_35.1	—	—	P132	BN132S4	207
28.8	5.5	1912	3824	1.1	0.5	34.7	25000	C702_34.7	—	—	P132	BN132S4	204-205
32	6.1	1725	3449	2.1	1.1	31.3	35000	C802_31.3	—	—	P132	BN132S4	206
34	6.5	1620	3240	3.6	1.8	29.4	50570	C902_29.4	—	—	P132	BN132S4	207
36	6.9	1526	3053	1.4	0.7	27.7	25000	C702_27.7	—	—	P132	BN132S4	204-205
37	7.0	1499	2997	3.7	1.8	27.2	49680	C902_27.2	—	—	P132	BN132S4	207
39	7.3	1427	2854	2.6	1.3	25.9	35000	C802_25.9	—	—	P132	BN132S4	206
42	7.9	1322	2645	2.7	1.3	24.0	35000	C802_24.0	—	—	P132	BN132S4	206
44	8.3	1262	2524	1.7	0.8	22.9	25000	C702_22.9	—	—	P132	BN132S4	204-205
45	8.6	1223	2446	3.0	1.5	22.2	35000	C802_22.2	—	—	P132	BN132S4	206
49	9.3	1130	2259	3.1	1.6	20.5	35000	C802_20.5	—	—	P132	BN132S4	206
52	9.8	1063	2127	2.0	1.0	19.3	25000	C702_19.3	—	—	P132	BN132S4	204-205
55	10.5	997	1995	3.7	1.9	18.1	35000	C802_18.1	—	—	P132	BN132S4	206
56	10.7	975	1951	1.4	0.7	17.7	14000	C612_17.7	V10 P132	V 10 C V 10 F	P132	BN132MA4	202-203
63	11.9	876	1752	1.5	0.8	15.9	13900	C612_15.9	V10 P132	V 10 C V 10 F	P132	BN132MA4	202-203



7.5 kW





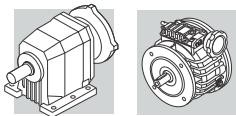

n_2 min ⁻¹	n_2' min ⁻¹	M ₂ Nm	M _{2'} Nm	S	S'	i	R _{n2} N					IEC 	
65	12.4	843	1686	2.5	1.2	15.3	23930	C702_15.3	—	—	P132	BN132S4	204-205
67	12.8	821	1642	4.5	2.3	14.9	35000	C802_14.9	—	—	P132	BN132S4	206
71	13.5	777	1554	2.8	1.4	14.1	23380	C702_14.1	—	—	P132	BN132S4	204-205
77	14.6	716	1433	2.9	1.5	13.0	22720	C702_13.0	—	—	P132	BN132S4	204-205
89	17.0	617	1234	3.5	1.7	11.2	21720	C702_11.2	—	—	P132	BN132S4	204-205
92	17.4	601	12010	2.2	1.1	10.9	13100	C612_10.9	V10 P132	V 10 C V 10 F	P132	BN132MA4	202-203
98	18.6	562	1124	3.7	1.9	10.2	21030	C702_10.2	—	—	P132	BN132S4	204-205
105	20.0	523	1047	4.1	2.1	9.5	21000	C702_9.5	—	—	P132	BN132S4	204-205
114	21.6	485	970	2.8	1.4	8.8	12600	C612_8.8	V10 P132	V 10 C V 10 F	P132	BN132MA4	202-203
133	25.3	413	827	3.3	1.6	7.5	12200	C612_7.5	V10 P132	V 10 C V 10 F	P132	BN132MA4	202-203
149	28.4	369	738	3.7	1.8	6.7	11900	C612_6.7	V10 P132	V 10 C V 10 F	P132	BN132MA4	202-203
167	32	331	661	2.0	1.0	6.0	10300	C612_6.0	V10 P132	V 10 C V 10 F	P132	BN132MA4	202-203
217	41	253	507	2.6	1.3	4.6	9600	C612_4.6	V10 P132	V 10 C V 10 F	P132	BN132MA4	202-203
270	51	204	408	3.1	1.6	3.7	9100	C612_3.7	V10 P132	V 10 C V 10 F	P132	BN132MA4	202-203
357	68	154	309	3.7	2.2	2.8	8400	C612_2.8	V10 P132	V 10 C V 10 F	P132	BN132MA4	202-203

9.2 kW

6.6	1.3	10071	20142	1.2	0.6	150.4	85000	C1003_150.4	—	—	P132	BN132MB4	208
7.2	1.4	9354	18709	1.2	0.6	139.7	85000	C1003_139.7	—	—	P132	BN132MB4	208
8.3	1.6	8069	16137	1.5	0.7	120.5	85000	C1003_120.5	—	—	P132	BN132MB4	208
8.9	1.7	7493	14986	1.6	0.8	111.9	85000	C1003_111.9	—	—	P132	BN132MB4	208
10.0	1.9	6683	13365	1.8	0.9	99.8	85000	C1003_99.8	—	—	P132	BN132MB4	208
10.8	2.0	6207	12414	1.9	1.0	92.7	85000	C1003_92.7	—	—	P132	BN132MB4	208
11.7	2.2	5732	11464	2.1	1.0	85.6	85000	C1003_85.6	—	—	P132	BN132MB4	208
12.6	2.4	5317	10633	2.3	1.1	79.4	85000	C1003_79.4	—	—	P132	BN132MB4	208
14.4	2.7	4647	9294	2.6	1.3	69.4	85000	C1003_69.4	—	—	P132	BN132MB4	208
15.5	2.9	4326	8651	1.7	0.8	64.6	56870	C903_64.6	—	—	P132	BN132MB4	207
16.0	3.0	4185	8370	1.0	0.5	62.5	35000	C803_62.5	—	—	P132	BN132MB4	206
17.5	3.3	3837	7674	1.0	0.5	57.3	35000	C803_57.3	—	—	P132	BN132MB4	206
18.2	3.5	3676	7352	2.0	1.0	54.9	55550	C903_54.9	—	—	P132	BN132MB4	207
19.9	3.8	3368	6736	2.1	1.1	50.3	54780	C903_50.3	—	—	P132	BN132MB4	207
21.1	4.0	3174	6348	1.3	0.6	47.4	35000	C803_47.4	—	—	P132	BN132MB4	206
23.0	4.4	2913	5826	1.4	0.7	43.5	35000	C803_43.5	—	—	P132	BN132MB4	206



9.2 kW

n_2 min ⁻¹	n_2' min ⁻¹	M_2 Nm	M_2' Nm	S	S'	i	R_{n2} N					IEC 	
23.3	4.4	2879	5759	2.5	1.3	43.0	53310	C903_43.0	— P132	— V 10 F	P132	BN132MB4	207
25.4	4.8	2638	5276	2.7	1.3	39.4	52460	C903_39.4	— P132	— V 10 F	P132	BN132MB4	207
25.6	4.9	2674	5349	1.2	0.6	39.1	35000	C802_39.1	— P132	— V 10 F	P132	BN132MB4	206
28.5	5.4	2401	4802	2.2	1.1	35.1	51140	C902_35.1	— P132	— V 10 F	P132	BN132MB4	207
32	6.1	2141	4282	1.7	0.9	31.3	35000	C802_31.3	— P132	— V 10 F	P132	BN132MB4	206
34	6.5	2011	4022	2.9	1.5	29.4	49340	C902_29.4	— P132	— V 10 F	P132	BN132MB4	207
36	6.9	1895	3789	1.1	0.6	27.7	24630	C702_27.7	— P132	— V 10 F	P132	BN132MB4	204-205
37	7.0	1860	3721	3.0	1.5	27.2	48560	C902_27.2	— P132	— V 10 F	P132	BN132MB4	207
39	7.3	1772	3543	2.1	1.0	25.9	35000	C802_25.9	— P132	— V 10 F	P132	BN132MB4	206
42	7.9	1642	3283	2.2	1.1	24.0	35000	C802_24.0	— P132	— V 10 F	P132	BN132MB4	206
44	8.3	1566	3133	1.3	0.7	22.9	24680	C702_22.9	— P132	— V 10 F	P132	BN132MB4	204-205
44	8.3	1566	3133	4.0	2.0	22.9	46760	C902_22.9	— P132	— V 10 F	P132	BN132MB4	207
49	9.3	1402	2804	2.5	1.3	20.5	35000	C802_20.5	— P132	— V 10 F	P132	BN132MB4	206
52	9.8	1320	2640	1.6	0.8	19.3	24500	C702_19.3	— P132	— V 10 F	P132	BN132MB4	204-205
60	11.4	1142	2285	1.8	0.9	16.7	24100	C702_16.7	— P132	— V 10 F	P132	BN132MB4	204-205
60	11.4	1142	2285	3.1	1.5	16.7	35000	C802_16.7	— P132	— V 10 F	P132	BN132MB4	206
63	11.9	1088	2175	1.2	0.6	15.9	12500	C612_15.9	V10 P132	V 10 C V 10 F	P132	BN132MB4	202-203
65	12.4	1047	2093	2.0	1.0	15.3	24080	C702_15.3	— P132	— V 10 F	P132	BN132MB4	204-205
67	12.8	1019	2038	3.6	1.8	14.9	33900	C802_14.9	— P132	— V 10 F	P132	BN132MB4	206
70	13.3	978	1956	1.4	0.7	14.3	12200	C612_14.3	V10 P132	V 10 C V 10 F	P132	BN132MB4	202-203
71	13.5	964	1929	2.2	1.1	14.1	23530	C702_14.1	— P132	— V 10 F	P132	BN132MB4	204-205
72	13.8	944	1888	3.7	1.9	13.8	33200	C802_13.8	— P132	— V 10 F	P132	BN132MB4	206
77	14.6	889	1778	2.4	1.2	13.0	22860	C702_13.0	— P132	— V 10 F	P132	BN132MB4	204-205
83	15.7	828	1655	1.6	0.8	12.1	11900	C612_12.1	V10 P132	V 10 C V 10 F	P132	BN132MB4	202-203
83	15.8	821	1642	4.5	2.3	12.0	31700	C802_12.0	— P132	— V 10 F	P132	BN132MB4	206
89	17.0	766	1532	2.8	1.4	11.2	21860	C702_11.2	— P132	— V 10 F	P132	BN132MB4	204-205
98	18.6	698	1395	3.0	1.5	10.2	21140	C702_10.2	— P132	— V 10 F	P132	BN132MB4	204-205
102	19.4	670	1341	2.0	1.0	9.8	11500	C612_9.8	V10 P132	V 10 C V 10 F	P132	BN132MB4	202-203
105	20.0	650	1300	3.3	1.7	9.5	24750	C702_9.5	— P132	— V 10 F	P132	BN132MB4	204-205
114	21.6	602	1204	2.2	1.1	8.8	11200	C612_8.8	V10 P132	V 10 C V 10 F	P132	BN132MB4	202-203
133	25.3	513	1026	4.1	2.1	7.5	19520	C702_7.5	— P132	— V 10 F	P132	BN132MB4	204-205
133	25.3	513	1026	2.6	1.3	7.5	10800	C612_7.5	V10 P132	V 10 C V 10 F	P132	BN132MB4	202-203
149	28.4	458	917	2.9	1.5	6.7	10500	C612_6.7	V10 P132	V 10 C V 10 F	P132	BN132MB4	202-203
167	32	410	821	1.6	0.8	6.0	10000	C612_6.0	V10 P132	V 10 C V 10 F	P132	BN132MB4	202-203

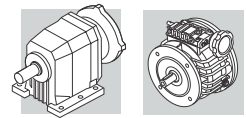

9.2 kW

n ₂ min ⁻¹	n ₂ ' min ⁻¹	M ₂ Nm	M ₂ ' Nm	S	S'	i	R _{n2} N					
217	41	315	629	2.1	1.1	4.6	9370	C612_4.6	V10 P132	V 10 C V 10 F	P132	BN132MB4 202-203
270	51	253	506	2.5	1.3	3.7	8890		V10 P132	V 10 C V 10 F		
357	68	192	383	3.0	1.7	2.8	8270		V10 P132	V 10 C V 10 F		

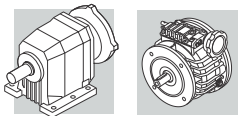

C 11

23.10 - Dimensioni

23.10 - Dimensions

23.10 - Abmessungen

23.10 - Dimensions

C 112_P + V_P(IEC)

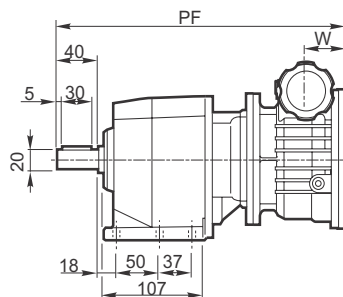
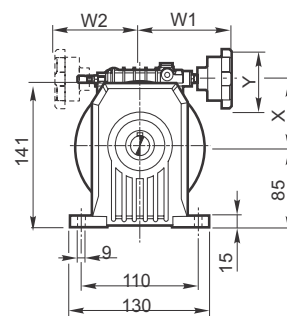
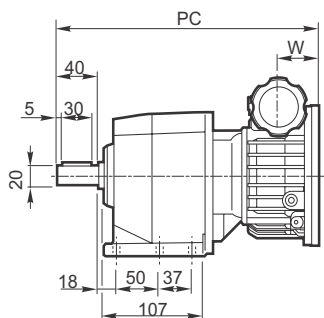
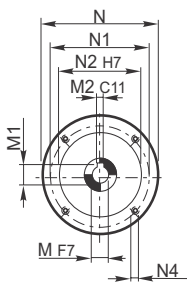

C 112_F + V_P(IEC)

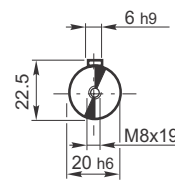
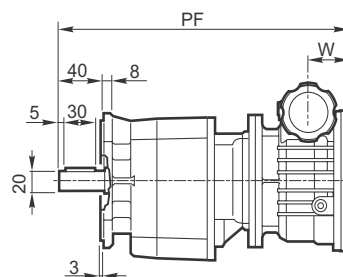
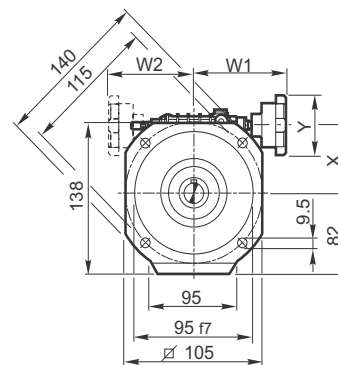
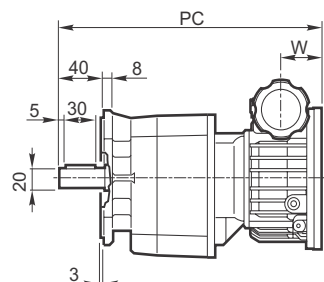
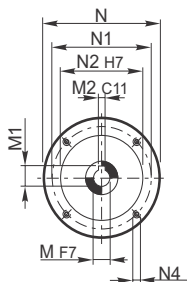

C 112_U + V_P(IEC)

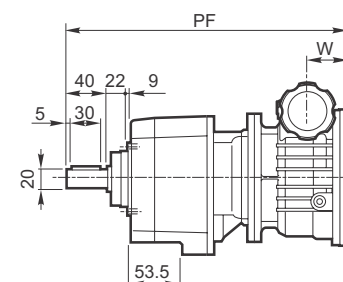
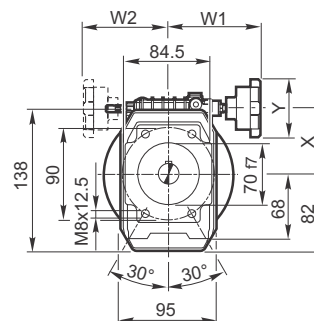
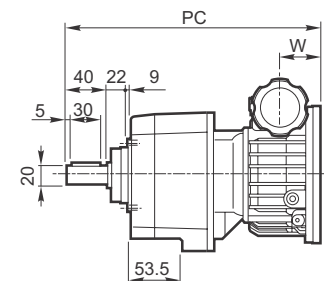
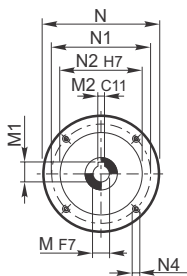

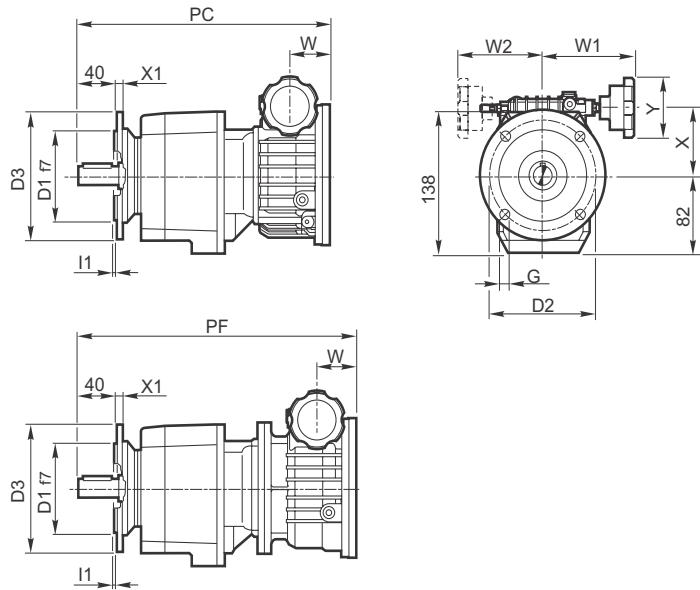
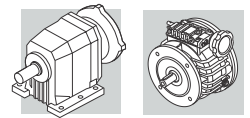

C112_UF + V_P(IEC)

UF	D ₁	D ₂	D ₃	G	l ₁	X ₁
C 112_UFA	80	100	120	7	2.5	9
C 112_UFB	95	115	140	9	3	10
C 112_UFC	110	130	160	9	3	10

	IEC	V_C - V_F											C 11_ + V_C			C 11_ + V_F						
		N	N1	N2	N4	M	M1	M2	W	W1	W2	X	Y	PC	Kg			PF	Kg			
															P	F	U		P	F	U	
C 112_	V 0.25	P63	140	115	95	M8x20	11	12.8	4	45	115	110	70	83	271	7.9	7.6	7.4	353	9.9	9.6	9.4
	V 0.5	P71	160	130	110	M8x20	14	16.3	5	47.5	115	110	78	83	274	11.1	10.7	10.6	355	13.1	12.7	12.6
	V 0.5	P80	200	165	130	M10x20	19	20.8**	6	51.5	115	110	78	83	278	11.1	10.7	10.6	359	13.1	12.7	12.6

C 112 + V_P + BN

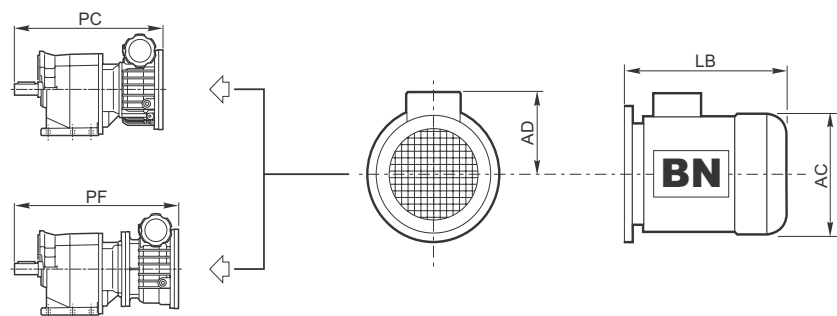

	IEC	BN			C 11_ + V_C + BN					C 11_ + V_F + BN				
		AC	AD	LB	PC+LB	Kg			PF+LB	Kg				
						P	F	U		P	F	U		
C 112_	V 0.25	63	121	95	184	455	11.8	11.5	11.3	537	13.8	13.5	13.3	
	V 0.25	71R	138	108	219	490	13.3	13.0	12.8	572	15.3	15.0	14.8	
	V 0.5	71	138	108	219	493	17.0	16.6	16.5	574	19.0	18.6	18.5	
	V 0.5	80	156	119	234	512	21.0	20.6	20.5	593	13.0	22.6	22.5	

** Utilizzare linguetta ribassata 6x5x30 "A"

** Use lowered key 6x5x30 "A"

** Den abgeflachten Federkeil 6x5x30 "A" verwenden

** Utiliser une languette rabaisée taille 6x5x30 "A"

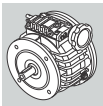
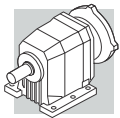

C 21

C 21_P + V_P(IEC)

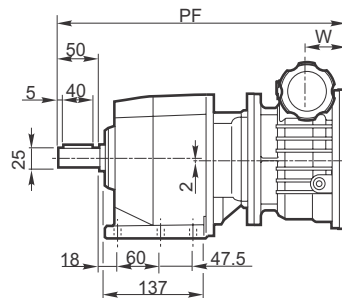
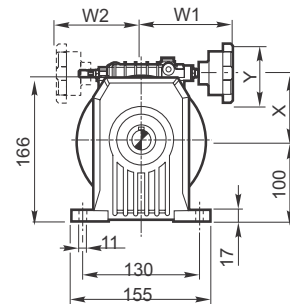
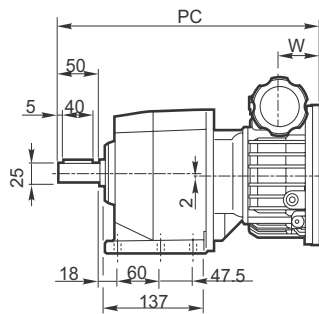
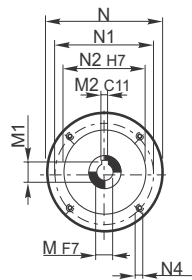

C 21_F + V_P(IEC)

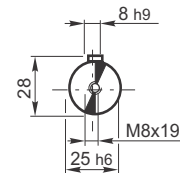
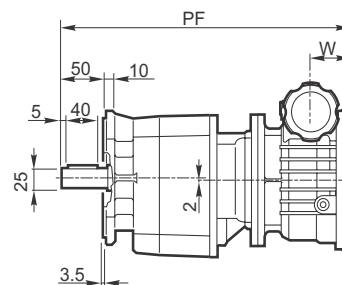
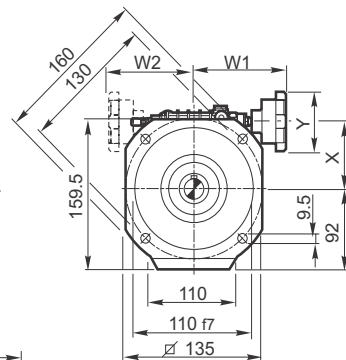
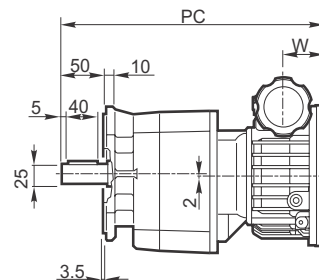
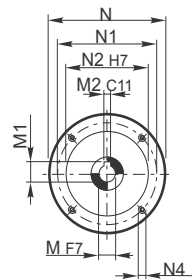

C 21_U + V_P(IEC)

