

**M6 - MOTORI AUTOFRENANTI
IN C.C., TIPO BN_FD**

**M6 - DC BRAKE MOTORS
TYPE BN_FD**

**M6 - DREHSTROMBREMSMO-
TOREN MIT GLEICH-
STROMBREMSE: TYP
BN_FD**

**M6 - MOTEURS FREIN EN C.C.,
TYPE BN_FD**

Grandezze: BN 63 ... BN 200L

Frame sizes: BN 63 ... BN 200L

Baugrößen: BN 63 ... BN 200L

Tailles : BN 63 ... BN 200L

(A49)

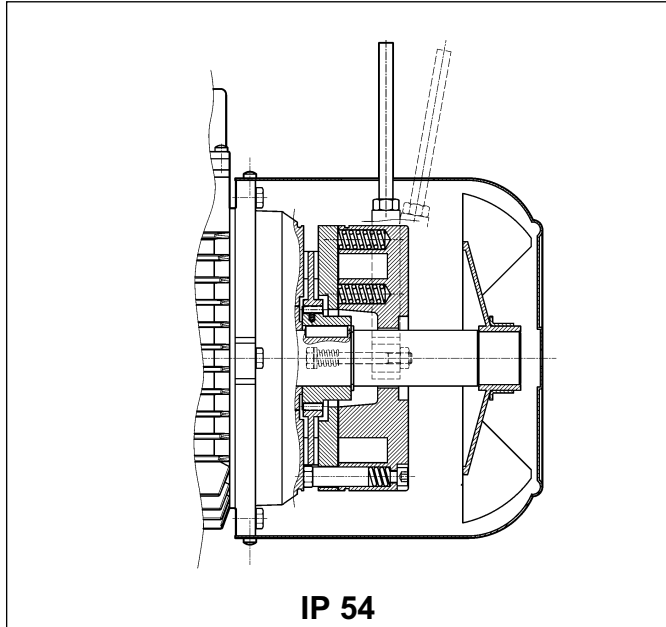

IP 54

(A50)

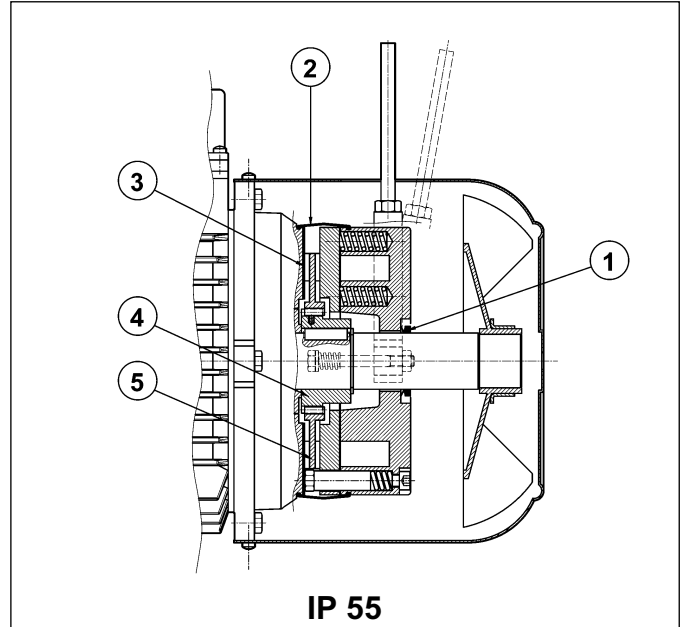

IP 55

Freno elettromagnetico con bobina toroidale in **corrente continua** fissato con viti allo scudo motore; le molle di precarico realizzano il posizionamento assiale del corpo magnete.

Il disco freno è scorrevole sul mozzo trascinatore in acciaio calettato sull'albero e previsto di molla antivibrazione.

I motori sono forniti con freno tarato in fabbrica al valore di coppia riportato nelle tabelle dati tecnici; la coppia frenante può essere regolata modificando il tipo e/o il numero delle molle.

A richiesta, i motori possono essere previsti di leva per lo sblocco manuale con ritorno automatico (**R**) o con mantenimento della posizione di rilascio freno (**RM**); per la posizione angolare della leva di sblocco vedi descrizione della relativa variante alla pag. 173.

Il freno FD garantisce elevate prestazioni dinamiche e bassa rumorosità; le caratteristiche d'intervento del freno in corrente continua possono essere ottimizzate in funzione dell'applicazione, utilizzando i vari tipi di alimentatore disponibili e/o realizzando l'opportuno cablaggio.

Direct current toroidal-coil electromagnetic brake bolted onto motor shield. Preloading springs provide axial positioning of magnet body.

Brake disc slides axially on steel hub shrunk onto motor shaft with anti-vibration spring.

Brake torque factory setting is indicated in the corresponding motor rating charts. Braking torque may be modified by changing the type and/or number of springs.

*At request, motors may be equipped with manual release lever with automatic return (**R**) or system for holding brake in the released position (**RM**).*

See variant at page 173 for available release lever locations.

FD brakes ensure excellent dynamic performance with low noise. DC brake operating characteristics may be optimized to meet application requirements by choosing from the various rectifier/power supply and wiring connection options available.

Elektromagnetische Bremse mit Ringwicklungsspule für **Gleichstromspannung**, die mittels Schrauben am hinteren Motorschild befestigt ist. Die Federn sorgen für die axiale Ausrichtung des Magnetkörpers.

Die Bremsscheibe gleitet axial auf der Mitnehmernabe aus Stahl, die über eine Paßfeder mit der Motorwelle verbunden und mit einer Schwingungsdämpfung ausgestattet ist.

Die Motoren werden vom Hersteller auf den in der Tabelle der technischen Daten angegebenen Bremsmoment eingestellt; das Bremsmoment kann durch das Ändern des Typs und/oder der Anzahl der Federn reguliert werden.

Auf Anfrage können die Motoren mit einem Bremslüfthebel für die manuelle Lüftung der Bremse mit selbstständiger Rückstellung (**R**) ohne Arretierung oder mit arretierbarem Lüfthebel (**RM**) geliefert werden. Die Festlegung der Position des Bremslüfthebel in Abhängigkeit von der Klemmkastenlage erfolgt durch die Option auf Seite 173.

Die Bremse vom Typ FD garantiert hohe dynamische Leistungen und niedrige Laufgeräusche. Die Ansprechigenschaften der Bremse unter Gleichstrom können in Abhängigkeit zur jeweiligen Anwendung durch den Einsatz der verschiedenen verfügbaren Gleichrichter oder durch eine entsprechenden Anschluß der Bremse optimiert werden.

Frein électromagnétique avec bobine toroïdale en **courant continu**, fixé avec des vis au bouclier moteur; les ressorts de précharge réalisent le positionnement axial de la bobine.

Le disque frein coulisse de façon axiale sur le moyeu d'entraînement en acier calé sur l'arbre et doté de ressort antivibration.

Les moteurs sont fournis avec frein pré réglé en usine à la valeur de couple indiquée dans les tableaux des caractéristiques techniques; le couple de freinage peut être réglé en modifiant le type et/ou le nombre de ressorts.

Sur demande, les moteurs peuvent être équipés de levier pour le déblocage manuel avec retour automatique (**R**) ou avec maintien de la position de déblocage frein (**RM**); pour la position angulaire du levier de déblocage, voir description de la variante correspondante à la page 173.

Le frein FD garantit des performances dynamiques élevées et un faible niveau de bruit; les caractéristiques d'intervention du frein en courant continu peuvent être optimisées en fonction de l'application en utilisant les différents types de dispositifs d'alimentation disponibles et/ou en réalisant un câblage approprié.

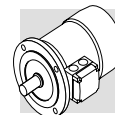

Grado di protezione

Protection class

Schutzart

Degré de protection

L'esecuzione standard prevede il grado di protezione IP54. In opzione il motore autofrenante tipo FD viene fornito con grado di protezione **IP 55**, prevedendo le seguenti varianti costruttive:

Standard protection class is IP54.

Brake motor FD is also available in protection class **IP 55**, which mandates the following variants:

Die Standardausführung ist Schutzart IP54 vor. Optional kann der Bremsmotor vom Typ FD in der Schutzart **IP 55** geliefert werden, wobei sind folgende Komponenten eingesetzt werden:

L'exécution standard prévoit le degré de protection IP54.

En option, le moteur frein type FD est fourni avec degré de protection **IP 55**, en prévoyant les variantes de construction suivantes :

- ① anello V-ring posizionato sull'albero motore N.D.E.
- ② fascia di protezione in gomma
- ③ anello in acciaio inox interposto tra scudo motore e disco freno
- ④ mozzo trascinatore in acciaio inox
- ⑤ disco freno in acciaio inox

- ① V-ring at N.D.E. of motor shaft
- ② dust and water-proof rubber boot
- ③ stainless steel ring placed between motor shield and brake disc
- ④ stainless steel hub
- ⑤ stainless steel brake disc

- ① V-Ring an der Motorwelle N.D.E.
- ② Schutzring aus Gummi
- ③ Ring aus rostfreiem Stahl zwischen Motorschild und Bremsscheibe
- ④ Bremsscheibe Mitnehmer aus rostfreiem Stahl
- ⑤ Bremsscheibe aus rostfreiem Stahl

- ① bague V-ring positionnées sur l'arbre moteur N.D.E.
- ② bande de protection en caoutchouc
- ③ bague en acier inox interposée entre le bouclier moteur et le disque de frein
- ④ moyeu d'entraînement en acier inox
- ⑤ disque frein en acier inox

Alimentazione freno FD

FD brake power supply

Spannungsversorgung der Bremse FD

Alimentation frein FD

L'alimentazione della bobina freno in c.c. è prevista per mezzo di opportuno raddrizzatore montato all'interno della scatola coprimorsetti e già cablato alla bobina del freno.

A rectifier accommodated inside the terminal box feeds the DC brake coil. Wiring connection across rectifier and brake coil is performed at the factory.

Die Versorgung der Gleichstrombremsspule erfolgt über einen Gleichrichter im Klemmenkasten der bei Lieferung, wenn nicht anders bestellt, bereits mit der Bremsspule verkabelt ist.

L'alimentation de la bobine de frein en c.c. est prévue au moyen d'un redresseur approprié monté à l'intérieur de la boîte à bornes et déjà câblé à la bobine de frein.

Per motori a singola polarità è inoltre previsto di serie il collegamento del raddrizzatore alla morsettiera motore.

On all single-pole motors, rectifier is connected to the motor terminal board.

Bei den einpoligen Motoren ist serienmäßig der Anschluss des Gleichrichters an die Motorspannung vorgesehen.

De plus, pour les moteurs à simple polarité, le raccordement du redresseur au bornier moteur est prévu de série.

Indipendentemente dalla frequenza di rete, la tensione standard di alimentazione del raddrizzatore V_B ha il valore indicato nella tabella (A51) qui di seguito:

Rectifier standard power supply voltage V_B is as indicated in the following table (A51), regardless of mains frequency:

Unabhängig von der Netzfrequenz erfolgt die Versorgung des Gleichrichters V_B über die in der nachstehenden Tabelle (A51) angegebenen Standardspannung:

Indépendamment de la fréquence du réseau, la tension standard d'alimentation du redresseur V_B correspond à la valeur indiquée dans le tableau (A51) ci-dessous :

(A51)

2, 4, 6 P				1 speed	
		BN_FD / M_FD		alimentazione freno da morsettiera brake connected to terminal board power supply Bremsversorgung über die Motorspannung Alimentation frein depuis boîte à bornes	
		$V_{mot} \pm 10\%$ 3 ~	$V_B \pm 10\%$ 1 ~		alimentazione separata separate power supply Separate Versorgung Alimentation séparée
BN 63...BN 132	M05...M4LB	230/400 V – 50 Hz	230 V	standard	specificare $V_B SA$ o $V_B SD$ specify $V_B SA$ or $V_B SD$ $V_B SA$ oder $V_B SD$ angeben spécifier $V_B SA$ ou $V_B SD$
BN 160...BN 200	M4LC...M5	400/690 V – 50 Hz	400 V	standard	specificare $V_B SA$ o $V_B SD$ specify $V_B SA$ or $V_B SD$ $V_B SA$ oder $V_B SD$ angeben spécifier $V_B SA$ ou $V_B SD$

Per i motori a doppia polarità l'alimentazione standard del freno è da linea separata con tensione d'ingresso al raddrizzatore V_B come indicato in tabella (A52):

Switch-pole motors feature a separate power supply line for the brake with rectifier input voltage V_B as indicated in the table (A52):

Die polumschaltbaren Motoren müssen immer mit separater Bremsversorgungsspannung betrieben werden, deshalb erfolgt die Lieferung standardmäßig ohne Anschluß der Bremse an die Motorspannung, da diese mit einer am Eingang des Gleichrichters V_B anliegenden Spannung versorgt werden muß, entsprechend Werte in der nachstehenden Tabelle (A52):

Pour les moteurs à double polarité, l'alimentation standard du frein dérive d'une ligne séparée avec tension d'entrée au redresseur V_B comme indiqué dans le tableau (A52):

(A52)

2/4, 2/6, 2/8, 2/12, 4/6, 4/8 P				2 speed	
		BN_FD / M_FD		alimentazione freno da morsettiera brake powered via terminal board Bremsversorgung über die Motorspannung Alimentation frein depuis boîte à bornes	
		$V_{mot} \pm 10\%$ 3 ~	$V_B \pm 10\%$ 1 ~		alimentazione separata separate power supply Separate Versorgung Alimentation séparée
BN 63...BN 132	M05...M4LB	400 V – 50 Hz	230 V		specificare $V_B SA$ o $V_B SD$ specify $V_B SA$ or $V_B SD$ $V_B SA$ oder $V_B SD$ angeben spécifier $V_B SA$ ou $V_B SD$

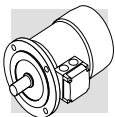

Il raddrizzatore è del tipo a diodi a semionda ($V_{c.c} \approx 0,45 \times V_{c.a.}$) ed è disponibile nelle versioni **NB**, **SB**, **NBR** e **SBR**, come dettagliato nella tabella (A53) seguente:

The diode half-wave rectifier ($V_{DC} \approx 0,45 \times V_{AC}$) is available in versions **NB**, **SB**, **NBR** e **SBR**, as detailed in the table (A53) below:

Bei dem Gleichrichter handelt es sich um einen Typ mit Halbwellendioden ($V_{c.c} \approx 0,45 \times V_{c.a.}$). Er ist in den Versionen **NB**, **SB**, **NBR** und **SBR**, gemäß den Details in der nachstehenden Tabelle (A53), verfügbar:

Le redresseur est du type à diodes à demi-onde ($V_{c.c} \approx 0,45 \times V_{c.a.}$) et il est disponible dans les versions **NB**, **SB**, **NBR** et **SBR**, comme indiqué de façon détaillée dans le tableau (A53) suivant :

(A53)

		freno brake Bremsen frein		
			standard	a richiesta at request auf Anfrage Sur demande
BN 63	M05	FD 02	NB	SB, SBR, NBR
BN 71	M1	FD 03		
BN 80	M2	FD 04		
BN 90S	—	FD 14		
BN 90L	—	FD 05		
BN 100	M3	FD 15		
—	—	FD 55		
BN 112	—	FD 06S	SB	SBR
BN 132...160MR	M4	FD 56		
BN 160L - BN 180M	M5	FD 06		
BN 180L - NM 200L	—	FD 07		

Il raddrizzatore **SB** a controllo elettronico dell'eccitazione, riduce i tempi di sblocco del freno sovraccitando l'elettromagnete nei primi istanti d'inserzione, per passare poi al normale funzionamento a semionda a distacco del freno avvenuto.

Rectifier **SB** with electronic energizing control over-energizes the electromagnet upon power-up to cut brake release response time and then switches to normal half-wave operation once the brake has been released.

Der Gleichrichter **SB** mit elektronischer Kontrolle der Erregung reduziert die Bremslösezeiten, indem er die Bremsspule in den ersten Momenten der Einschaltung übermäßig erregt, um dann, nach erfolgter Bremslösung, in die normale Halbwellenfunktion umzuschalten.

Le redresseur **SB** à contrôle électronique de l'excitation réduit les temps de déblocage du frein en surexcitant l'électro-aimant durant les premiers instants d'enclenchement pour passer ensuite au fonctionnement normal à demi-onde une fois le frein désactivé.

L'impiego del raddrizzatore tipo **SB** è sempre da prevedere nei casi di:

- elevato numero di interventi orari
- tempi di sblocco freno ridotti
- elevate sollecitazioni termiche del freno

Use of the **SB** rectifier is mandatory in the event of:

- high number of operations per hour
- reduced brake release response time
- brake is exposed to extreme thermal stress

Der Einsatz eines Gleichrichters vom Typ **SB** wird in folgenden Fällen empfohlen:

- hohe Anzahl von Schaltungen pro Stunde
- schnelle Bremsansprechzeiten
- starke thermische Beanspruchungen der Bremse

L'utilisation du redresseur type **SB** doit toujours être prévue dans les cas suivants :

- nombre d'interventions horaires élevé
- temps de déblocage frein réduits
- sollicitations thermiques du frein élevées

Per applicazioni dove è richiesto un rapido rilascio del freno sono disponibili a richiesta i raddrizzatori **NBR** o **SBR**.

Questi raddrizzatori completano i tipi **NB** e **SB**, integrando nel circuito elettronico un interruttore statico che interviene diseccitando rapidamente il freno in caso di mancanza di tensione. Questa soluzione consente di ridurre i tempi di rilascio del freno evitando ulteriori cablaggi e contatti esterni.

Per il migliore utilizzo dei raddrizzatori **NBR** e **SBR** è richiesta l'alimentazione separata del freno.

Tensioni disponibili: 230V \pm 10%, 400V \pm 10%, 50/60 Hz.

Rectifiers **NBR** or **SBR** are available for applications requiring quick brake release response.

These rectifiers complement the **NB** and **SB** types as their electronic circuit incorporates a static switch that de-energizes the brake quickly in the event voltage is missing. This arrangement ensures short brake release response time with no need for additional external wiring and contacts. Optimum performance of rectifiers **NBR** and **SBR** is achieved with separate brake power supply.

Available voltages: 230V \pm 10%, 400V \pm 10%, 50/60 Hz.

Für die Anwendungen, bei denen eine schnelle Ansprechzeit der Bremse gefordert wird, können auf Anfrage die Gleichrichter **NBR** oder **SBR** geliefert werden.

Diese Gleichrichter erweitern die Funktion der Typen **NB** und **SB**, indem in dem elektronischen Schaltkreis ein statischen Schalter integriert ist, durch dessen Auslösen die Bremse im Fall eines Spannungsausfalls schnell abgeregelt wird.

Diese Lösung ermöglicht eine Verringerung der Ansprechzeiten der Bremse, wodurch weitere Schaltungen und externe Sensoren vermieden werden können. Im Hinblick auf einen besseren Einsatz der Gleichrichter **NBR** und **SBR** ist bei der Bremse eine separate Versorgung erforderlich. Verfügbare Spannungen: 230V \pm 10%, 400V \pm 10%, 50/60 Hz.

Pour les applications nécessitant un déblocage rapide du frein, sur demande les redresseurs **NBR** ou **SBR** sont disponibles.

Ces redresseurs complètent les types **NB** et **SB**, en intégrant dans le circuit électronique un interrupteur statique qui intervient en désexcitant rapidement le frein en cas de coupure de tension.

Cette solution permet de réduire les temps de déblocage du frein en évitant d'autres câblages et contacts extérieurs.

Pour une meilleure utilisation des redresseurs **NBR** et **SBR** l'alimentation séparée du frein est nécessaire. Tensions disponibles : 230V \pm 10%, 400V \pm 10%, 50/60 Hz.

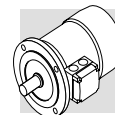

Dati tecnici freni FD

FD brake technical specifications

Technische Daten - Bremstyp FD

Caractéristiques techniques freins FD

Nella tabella (A54) sottostante sono riportati i dati tecnici dei freni in c.c. tipo FD.

The table (A54) below reports the technical specifications of DC brakes FD.

In der nachstehenden Tabelle (A54) werden die technischen Daten der Gleichstrombremsen vom Typ FD angegeben.

Le tableau (A54) suivant indique les caractéristiques techniques des freins en c.c. type FD.

(A54)

Freno Brake Bremse Frein	Coppia frenante M_b [Nm] Brake torque M_b [Nm] Bremsmoment M_b [Nm] Couple de freinage M_b [Nm]			Rilascio Release Anspruchzeit Déblocage		Frenatura Braking Bremsung Freinage		Wmax per frenata Wmax per brake operation Wmax pro Bremsung Wmax par freinage			W	P
	molle / springs feder / ressorts			t_1	t_{1s}	t_2	t_{2c}	[J]			[MJ]	[W]
	6	4	2	[ms]	[ms]	[ms]	[ms]	10 s/h	100 s/h	1000 s/h		
FD02	–	3.5	1.75	30	15	80	9	4500	1400	180	15	17
FD03	5	3.5	1.75	50	20	100	12	7000	1900	230	25	24
FD53	7.5	5	2.5	60	30	100	12					
FD04	15	10	5	80	35	140	15	10000	3100	350	30	33
FD14												
FD05	40	26	13	130	65	170	20	18000	4500	500	50	45
FD15	40	26	13	130	65	170	20					
FD55	55	37	18	–	65	170	20					
FD06S	60	40	20	–	80	220	25	20000	4800	550	70	55
FD56	–	75	37	–	90	150	20	29000	7400	800	80	65
FD06		100	50		100	150	20					
FD07	150	100	50	–	120	200	25	40000	9300	1000	130	65
FD08*	250	200	170	–	140	350	30	60000	14000	1500	230	100
FD09**	400	300	200	–	200	450	40	70000	15000	1700	230	120

* valori di coppia frenante ottenuti con n° 9, 7, 6 molle rispettivamente

* brake torque values obtained with 9, 7 and 6 springs, respectively

* Werte, der durch den Einsatz von jeweils 9, 7, 6 Federn erreichten Bremsmomente

* valeurs de couple de freinage obtenues respectivement avec n° 9, 7, 6 ressorts

** valori di coppia frenante ottenuti con n° 12, 9, 6 molle rispettivamente

** brake torque values obtained with 12, 9 and 6 springs, respectively

** Werte, der durch den Einsatz von jeweils 12, 9, 6 Federn erreichten Bremsmomente

** valeurs de couple de freinage obtenues respectivement avec n° 12, 9, 6 ressorts

Legenda:

Key:

Zeichenerklärung:

Légende:

t_1 = tempo di rilascio del freno con alimentatore a semionda
 t_{1s} = tempo di rilascio del freno con alimentatore a controllo elettronico dell'eccitazione
 t_2 = ritardo di frenatura con interruzione lato c.a. e alimentazione separata
 t_{2c} = ritardo di frenatura con interruzione lato c.a.e c.c. – I valori di t_1 , t_{1s} , t_2 , t_{2c} indicati nella tab. (A54) sono riferiti al freno tarato alla coppia massima, trafero medio e tensione nominale
 W_{max} = energia max per frenata
 W = energia di frenatura tra due regolazioni successive del trafero
 P_b = potenza assorbita dal freno a 20°C
 M_b = coppia frenante statica (±15%)
s/h = avviamenti orari

t_1 = brake release time with half-wave rectifier
 t_{1s} = brake release time with over-energizing rectifier
 t_2 = brake engagement time with AC line interruption and separate power supply
 t_{2c} = brake engagement time with AC and DC line interruption – Values for t_1 , t_{1s} , t_2 , t_{2c} indicated in the tab. (A54) are referred to brake set at maximum torque, medium air gap and rated voltage
 W_{max} = max energy per brake operation
 W = braking energy between two successive air gap adjustments
 P_b = brake power absorption at 20 °C
 M_b = static braking torque (±15%)
s/h = starts per hour

t_1 = Ansprechzeit der Bremse mit Halbwellengleichrichter
 t_{1s} = Ansprechzeit der Bremse mit elektronisch gesteuerten Erregungsgleichrichter
 t_2 = Bremsverzögerung mit Unterbrechung auf Wechselstromseite und Fremdversorgung
 t_{2c} = Bremsverzögerung mit Unterbrechung auf Wechselstrom- und Gleichstromseite – Die in der Tab. (A54) angegebenen Werte t_1 , t_{1s} , t_2 , t_{2c} beziehen sich auf eine auf das max. Bremsmoment geeichte Bremse, mit mittlerem Luftspalt und Nennspannung
 W_{max} = max. Energie pro Bremsung
 W = Bremsenergie zwischen zwei Einstellungen des Luftspalts
 P_b = bei 20 °C von der Bremse aufgenommene Leistung (50 Hz)
 M_b = statisches Bremsmoment (±15%)
s/h = Einschaltungen pro stunde

t_1 = temps de déblocage du frein avec dispositif d'alimentation à demi-onde
 t_{1s} = temps de déblocage du frein avec dispositif d'alimentation à contrôle électronique de l'excitation
 t_2 = retard de freinage avec interruption côté c.a. et alimentation séparée
 t_{2c} = retard de freinage avec interruption côté c.a. et c.c. – Les valeurs de t_1 , t_{1s} , t_2 , t_{2c} indiquées dans la tab. (A54) se réfèrent au frein étalonné au couple maximal, entrefer moyen et tension nominale
 W_{max} = énergie max. par freinage
 W = énergie de freinage entre deux réglages successifs de l'entrefer
 P_b = puissance absorbée par le frein à 20 °C
 M_b = couple de freinage statique (±15%)
s/h = démarrages horaires

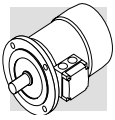

Collegamenti freno FD

I motori standard ad una velocità sono forniti con il collegamento del raddrizzatore alla morsettiera motore già realizzato in fabbrica. Per motori a 2 velocità, e dove è richiesta l'alimentazione del freno separata, prevedere il collegamento al raddrizzatore in accordo alla tensione freno V_B indicata nella targhetta del motore. **Data la natura induttiva del carico, per il comando del freno e per l'interruzione lato corrente continua devono essere utilizzati contatti con categoria d'impiego AC-3 secondo IEC 60947-4-1.**

Tabella (A55) - Alimentazione freno dai morsetti motore ed interruzione lato a.c.
Tempo di arresto t_2 ritardato e funzione delle costanti di tempo del motore. Da prevedere quando sono richiesti avviamenti/arresti progressivi.

Tabella (A56) - Bobina freno con alimentazione separata ed interruzione lato c.a.
Tempo di arresto normale ed indipendente dal motore. Si realizzano i tempi di arresto t_2 indicati nella tabella (A54).

Tabella (A57) - Bobina freno con alimentazione dai morsetti motore ed interruzione lato c.a. e c.c.
Arresto rapido con i tempi d'intervento t_{2c} indicati in tabella (A54).

Tabella (A87) - Bobina freno con alimentazione separata ed interruzione lato c.a. e c.c.
Tempo di arresto ridotto secondo i valori t_{2c} indicati in tabella (A54).

FD brake connections

On standard single-pole motors, the rectifier is connected to the motor terminal board at the factory. For switch-pole motors and where a separate brake power supply is required, connection to rectifier must comply with brake voltage V_B stated in motor name plate. **Because the load is of the inductive type, brake control and DC line interruption must use contacts from the usage class AC-3 to IEC 60947-4-1.**

Table (A55) - Brake power supply from motor terminals and AC line interruption
Delayed stop time t_2 and function of motor time constants. Mandatory when soft-start/stops are required.

Table (A56) - Brake coil with separate power supply and AC line interruption
Normal stop time independent of motor. Achieved stop times t_2 are indicated in the table (A54).

Table (A57) - Brake coil power supply from motor terminals and AC/DC line interruption.
Quick stop with operation times t_{2c} as per table (A54).

Table (A58) - Brake coil with separate power supply and AC/DC line interruption.
Stop time decreases by values t_{2c} indicated in the table (A54).

Anschlüsse - Bremstyp FD

Die einpoligen Motoren werden vom Werk ab mit an die Motorspannung angeschlossenem Gleichrichter geliefert. Für die polumschaltbaren Motoren, und Bremse mit separater Versorgung, wird in Übereinstimmung mit der auf dem Typenschild des Motors angegebenen Bremsspannung V_B der Anschluss an den Gleichrichter vorgesehen. **Da es sich bei der Bremsleistung um eine induktive Kraft handelt, müssen gemäß IEC 60947-4-1 für die Steuerung der Bremse und die Unterbrechung der Gleichstromseite Kontakte der Kategorie AC-3 verwendet werden.**

Tabelle (A55) - Bremsversorgung über die Motorspannung und Unterbrechung der Wechselstromseite.
Verzögerter und von den Zeitkonstanten des Motors abhängige Haltezeit t_2 .
Vorzu sehen, wenn progressive Starts/Stopps erforderlich sind.

Tabelle (A56) - Bremsspule mit separater Spannungsversorgung und Unterbrechung der Wechselstromseite. Normale und vom Motor unabhängige Stoppszeiten. Es werden die in der Tabelle (A54) angegebenen Stoppszeiten t_2 realisiert.

Tabelle (A57) - Bremsspule mit Versorgung über die Motorspannung und Unterbrechung der Gleich- und der Wechselstromseite. Schneller Stopp mit den in der Tabelle (A54) angegebenen Ansprechzeiten t_{2c} .

Tabelle (A58) - Bremsspule mit separater Spannungsversorgung und Unterbrechung der Gleich- und der Wechselstromseite. Reduzierte Stoppszeiten der in der Tabelle (A54) angegebenen Werte t_{2c} .

Raccordements frein FD

Les moteurs standard à une vitesse sont fournis avec le raccordement du redresseur au bornier moteur déjà réalisé en usine. Pour les moteurs à 2 vitesses, et lorsqu'une alimentation séparée du frein est requise, prévoir le raccordement au redresseur conformément à la tension frein V_B indiquée sur la plaque signalétique du moteur. **Étant donné la nature inductive de la charge, pour la commande du frein et l'interruption côté courant continu, il est nécessaire d'utiliser des contacts avec catégorie d'utilisation AC-3 selon la norme IEC 60947-4-1.**

Tableau (A55) - Alimentation frein depuis bornes moteur et interruption côté c.a.
Temps d'arrêt t_2 retardé et fonction des constantes de temps du moteur.
A prévoir lorsque des démarrages/arrests progressifs sont requis.

Tableau (A56) - Bobine de frein avec alimentation séparée et interruption côté c.a.
Temps d'arrêt normal et indépendant du moteur. Les temps d'arrêts t_2 sont ceux indiqués dans le tableau (A54).

Tableau (A57) - Bobine de frein avec alimentation depuis les bornes moteur et interruption côté c.a. et c.c.
Arrêt rapide avec les temps d'intervention t_{2c} indiqués dans le tableau (A54).

Tableau (A58) - Bobine de frein avec alimentation séparée et interruption côté c.a. et c.c.
Temps d'arrêt réduit selon les valeurs t_{2c} indiquées dans le tableau (A54).

(A55)

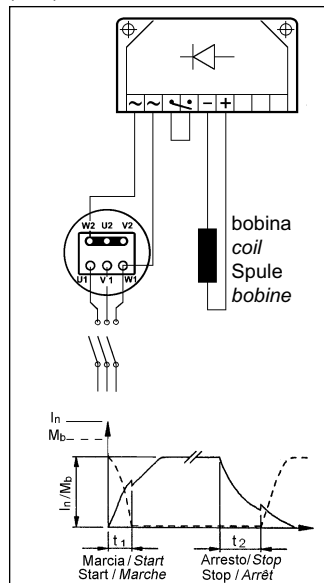

(A56)

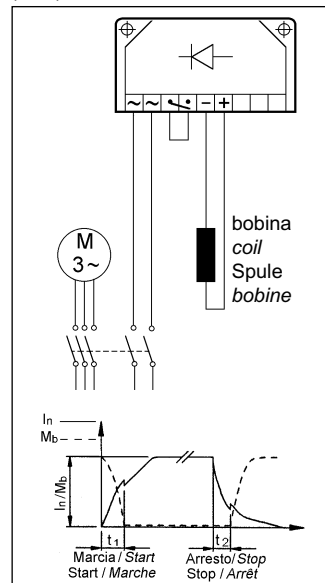

(A57)

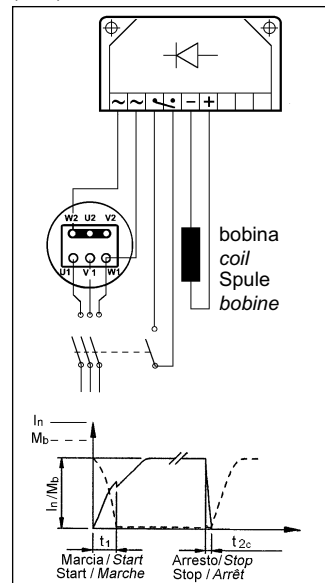

(A58)

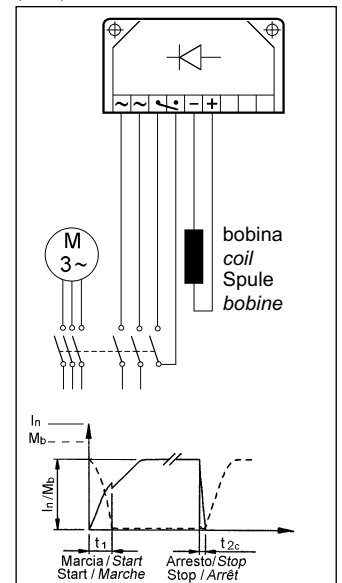

Le tabelle da (A55) a (A58) riportano gli schemi tipici di collegamento per alimentazione 400 V, motori 230/400V collegati a stella e freno 230 V.

Tables (A55) through (A58) show the typical connection diagrams for 400 V power supply, star-connected 230/400V motors and 230 V brake.

In den Tabellen (A55) bis (A58) werden die typischen Schaltungen für Versorgung mit 400 V, Motoren 230/400V mit Sternschaltung und einer Bremsspannung von 230 V wiedergegeben.

Les tableaux de (A55) à (A58) indiquent les schémas typiques de branchement pour une alimentation de 400 V, moteurs 230/400V raccordés en étoile et frein 230 V.

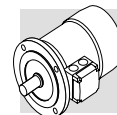

**M7 - MOTORI AUTOFRENANTI
IN C.A., TIPO BN_FA**

**M7 - AC BRAKE MOTORS
TYPE BN_FA**

**M7 - WECHSELSTROM-
BREMSMOTOREN-TYP
BN_FA**

**M7 - MOTEURS FREIN EN C.A.,
TYPE BN_FA**

Grandezze: BN 63 ... BN 180M

Frame sizes: BN 63 ... BN 180M

Baugrößen: BN 63 ... BN 180M

Tailles : BN 63 ... BN 180M

(A59)

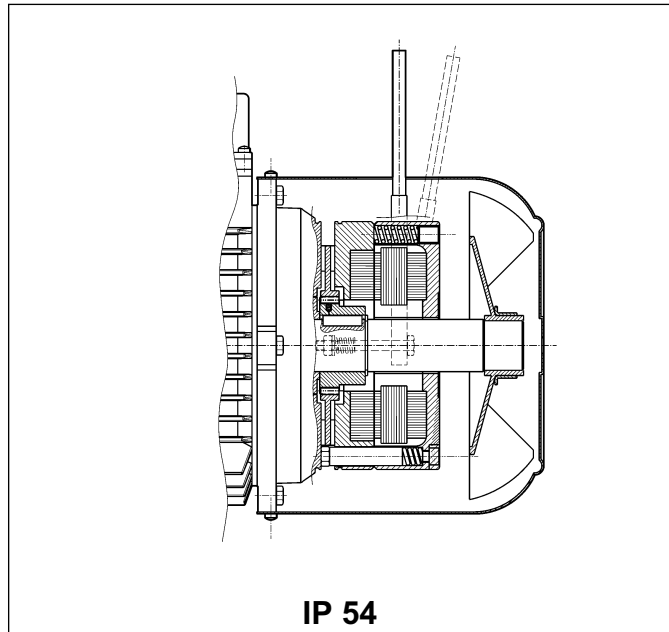

IP 54

(A60)

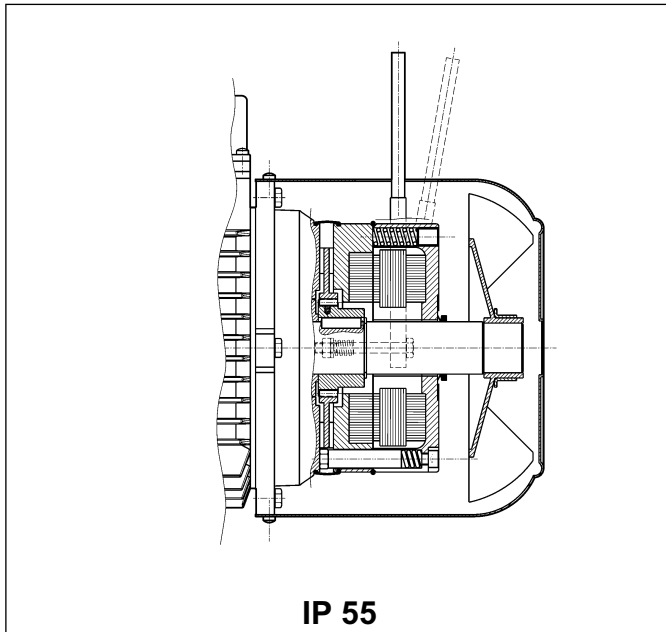

IP 55

Freno elettromagnetico con alimentazione in **corrente alternata** trifase, fissato con viti allo scudo motore; le molle di precarico realizzano il posizionamento assiale del corpo magnete.

Il disco freno è scorrevole assialmente sul mozzo trascinatore in acciaio calettato sull'albero e provvisto di molla antivibrazione. La coppia frenante è pre-impostata in fabbrica su valori che sono indicati nelle tabelle dati tecnici dei relativi motori.

L'azione del freno è inoltre modulabile, regolando con continuità la coppia frenante, tramite le viti che realizzano il precarico delle molle; il campo di regolazione della coppia è: $30\% M_{bMAX} < M_b < M_{bMAX}$ (M_{bMAX} è il momento frenante max riportato in tab. (A62)).

Il freno tipo FA presenta dinamiche molto elevate che lo rendono idoneo in applicazioni dove sono richieste frequenze di avviamento elevate con tempi d'intervento molto rapidi.

A richiesta, i motori possono essere previsti di leva per lo sblocco manuale con ritorno automatico (R). Per la specifica della posizione angolare della leva vedi relativa variante alla pag. 173.

*Electromagnetic brake operates from three-phase **alternated current** power supply and is bolted onto conveyor shield. Preloading springs provide axial positioning of magnet body.*

Steel brake disc slides axially on steel hub shrunk onto motor shaft with anti-vibration spring. Brake torque factory setting is indicated in the corresponding motor rating charts.

Spring preloading screws provide stepless braking torque adjustment.

Torque adjustment range is $30\% M_{bMAX} < M_b < M_{bMAX}$ (where M_{bMAX} is maximum braking torque as shown in tab. (A62)).

Thanks to their high dynamic characteristics, FA brakes are ideal for heavy-duty applications as well as applications requiring frequent stop/starts and very fast response time.

Motors may be equipped with manual release lever with automatic return (R) at request. See variants at page 173 for available lever locations.

Elektromagnetische Bremse mit **Drehstromversorgung**, die mittels Schrauben am hinteren Motorschild befestigt ist. Die Federn sorgen dabei für die axiale Ausrichtung des Magnetkörpers.

Die Bremsscheibe (Stahl) gleitet axial auf dem sich auf dem Rotor befindlichen Mitnehmer, der über eine Paßfeder mit Motorwelle verbunden und mit einer Schwingungsdämpffeder ausgestattet ist.

Das Bremsmoment wird auf das entsprechende Motormoment eingestellt (siehe Tabelle der technischen Daten der entsprechenden Motoren).

Das Bremsmoment ist stufenlos durch über die Schrauben die die Federvorspannung einstellbar. Der Einstellbereich beträgt $30\% M_{bMAX} < M_b < M_{bMAX}$ (M_{bMAX} steht für den max. Bremsmoment, der in der Tab (A62) angegeben wird).

Die Bremse vom Typ FA zeichnet sich durch ihre hohen Dynamik aus, weshalb sie für Anwendungen geeignet sind, in denen hohe Schaltfrequenzen und schnelle Ansprechzeiten gefordert werden.

Auf Anfrage können die Motoren mit einem Lüfterhebel für die manuelle Lüftung der Bremse mit automatischer Rückstellung (R) geliefert werden. Die Angabe der Montageposition erfolgt über die Angabe der Option auf Seite 173.

*Frein électromagnétique avec alimentation en **courant alternatif** triphasé, fixé avec des vis au bouclier; les ressorts de précharge réalisent le positionnement axial de la bobine.*

Le disque frein coulisse de façon axiale sur le moyeu d'entraînement en acier, calé sur l'arbre et doté de ressort antivibration.

Le couple de freinage est pré-réglé en usine aux valeurs qui sont indiquées dans les tableaux des caractéristiques techniques des moteurs correspondants.

De plus, l'action du frein est modulable, en réglant le couple de freinage en continu au moyen des vis qui réalisent la précharge des ressorts; la plage de réglage du couple est de $30\% M_{bMAX} < M_b < M_{bMAX}$ (M_{bMAX} est le couple de freinage maximum indiqué dans le tab. (A62)).

Le frein type FA présente des caractéristiques dynamiques très élevées, il est donc adapté pour des applications nécessitant des fréquences de démarrage élevées et des temps d'intervention très rapides.

Sur demande, les moteurs peuvent être prévus avec levier pour le déblocage manuel avec retour automatique (R). Pour la spécification de la position angulaire du levier, voir variante page 173.

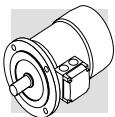

Grado di protezione

L'esecuzione standard prevede il grado di protezione IP54. In opzione, il motore autofrenante BN_FA viene fornito con grado di protezione **IP 55** prevedendo le seguenti varianti costruttive:

- anello V-ring posizionato sull'albero motore NDE.
- fascia di protezione in gomma
- anello O-ring

Protection class

Standard protection class is IP54. Brake motor BN_FA is also available in protection class **IP 55**, which mandates the following variants:

- V-ring at N.D.E. of motor shaft
- rubber protection sleeve
- O-ring

Schutzart

Die Standardausführung ist Schutzart IP54 vor. Optional kann der Bremsmotor BN_FA auch in der Schutzart **IP 55** geliefert werden, was durch die folgenden zusätzlichen Bauteile erreicht wird:

- V-Ring an der Motorwelle N.D.E.
- Schutzring aus Gummi
- O-Ring

Degré de protection

L'exécution standard prévoit le degré de protection IP54. En option, le moteur frein BN_FA est fourni avec degré de protection **IP 55**, les variations de construction suivantes sont prévues :

- bague V-ring positionné sur l'arbre moteur N.D.E.
- bande de protection en caoutchouc
- joint torique

Alimentazione freno FA

Nei motori a singola polarità l'alimentazione della bobina freno è derivata direttamente dalla morsettiera motore e la tensione del freno quindi coincide con la tensione del motore. In questo caso la tensione del freno può essere omessa dalla designazione

Per i motori a doppia polarità, e per i motori con alimentazione separata del freno, è presente una morsettiera ausiliaria con 6 terminali per il collegamento alla linea del freno. In entrambi i casi il valore di tensione del freno dovrà essere specificato in designazione.

Nella tabella seguente sono riportate le condizioni di alimentazione standard del freno in c.a. per i motori a singola e doppia polarità:

FA brake power supply

In single-pole motors, power supply is brought to the brake coil direct from the motor terminal box. As a result, brake voltage and motor voltage are the same. In this case, brake voltage indication may be omitted in the designation.

Switch-pole motors and motors with separate brake power supply feature an auxiliary terminal board with 6 terminals for connection to brake line. In both cases, brake voltage indication in the designation is mandatory. The following table reports standard AC brake power supply ratings for single- and switch-pole motors:

Stromversorgung - Bremstyp FA

Bei den einpoligen Motoren wird die Versorgung der Bremsspule direkt vom Motorklemmenkasten abgenommen, das bedeutet, dass die Spannung der Bremse mit der Motorspannung übereinstimmt. In diesem Fall braucht die Bremsenspannung nicht extra angegeben werden.

Für die polumschaltbaren Motoren und für eine separate Bremsversorgung ist eine Hilfsklemmenleiste mit 6 Anschlüssen vorgesehen, die einen Anschluß der Bremse ermöglichen. In beiden Fällen muss die Bremsspannung in der Bestellung angegeben werden.

In der nachstehenden Tabelle werden für die einpoligen und die polumschaltbaren Motoren die Standardspannungen der Wechselstrombremsen angegeben.

Alimentation frein FA

Sur les moteurs à simple polarité, l'alimentation de la bobine frein dérive directement du bornier moteur, par conséquent, la tension du frein coïncide avec la tension du moteur. Dans ce cas, la tension du frein peut être omise de la désignation.

Pour les moteurs à double polarité et les moteurs avec alimentation séparée du frein, une boîte à bornes auxiliaire avec 6 bornes pour le raccordement à la ligne du frein, est présente. Dans les deux cas, la valeur de tension du frein doit être spécifiée dans la désignation.

Le tableau suivant indique les conditions d'alimentation standard du frein en c.a. pour les moteurs à simple et double polarité :

(A61)

motori a singola polarità single-pole motor Einpolige Motoren Moteurs à simple polarité	BN 63...BN 132	BN 160...BN 180
	M05...M4LB	M4LC...M5
	230Δ / 400Y V ±10% – 50 Hz	400Δ / 690Y V ±10% – 50 Hz
	265Δ / 460Y ±10% - 60 Hz	460Y – 60 Hz

motori a doppia polarità (alimentazione da linea separata) switch-pole motors (separate power supply line) Polumschaltbare Motoren (separate Versorgung) Moteurs à double polarité (alimentation depuis ligne séparée)	BN 63...BN 132
	M05...M4
	230Δ / 400Y V ±10% – 50 Hz
	460Y - 60 Hz

Se non diversamente specificato, l'alimentazione standard del freno è 230Δ / 400Y V - 50 Hz.

Su richiesta, sono disponibili tensioni speciali, nel campo 24...690 V, 50-60 Hz.

Unless otherwise specified, standard brake power supply is 230Δ / 400Y V - 50 Hz.

Special voltages in the 24...690 V, 50-60 Hz range are available at request.

Falls nicht anderweitig angegeben, beträgt die Standardversorgung der Bremse 230Δ / 400Y V - 50 Hz.

Auf Anfrage können Sonderspannungen von 24...690 V, 50-60 Hz geliefert werden.

Sauf spécification contraire, l'alimentation standard du frein est 230Δ / 400Y V - 50 Hz.

Sur demande, des tensions spéciales sont disponibles dans la plage 24...690 V, 50-60 Hz.

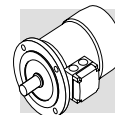

Dati tecnici freni FA

Technical specifications of FA brakes

Technische Daten der Bremsen vom Typ FA

Caractéristiques techniques freins FA

(A62)

Freno Brake Bremse Frein	Coppia frenante Brake torque Bremsmoment Couple de freinage	Rilascio Release Ansprechzeit Déblocage	Frenatura Braking Bremsung Freinage	Wmax			W	P _b			
				M _b [Nm]	t ₁ [ms]	t ₂ [ms]			[J]		
									10 s/h	100 s/h	1000 s/h
FA 02	3.5	4	20	4500	1400	180	15	60			
FA 03	7.5	4	40	7000	1900	230	25	80			
FA 04	15	6	60	10000	3100	350	30	110			
FA 14											
FA 05											
FA 15	40	8	90	18000	4500	500	50	250			
FA 06S	60	16	120	20000	4800	550	70	470			
FA 06	75	16	140	29000	7400	800	80	550			
FA 07	150	16	180	40000	9300	1000	130	600			
FA 08	250	20	200	60000	14000	1500	230	1200			

Legenda:

M_b = max coppia frenante statica (±15%)

t₁ = tempo di rilascio freno

t₂ = ritardo di frenatura

W_{max} = energia max per frenata (capacità termica del freno)

W = energia di frenatura tra due regolazioni successive del traferro

P_b = potenza assorbita dal freno a 20° (50 Hz)

s/h = avviamenti orari

N.B.

I valori di t₁ e t₂ riportati in tabella sono riferiti al freno tarato alla coppia nominale, traferro medio e tensione nominale.

Key:

M_b = max static braking torque (±15%)

t₁ = brake release time

t₂ = brake engagement time

W_{max} = max energy per brake operation (brake thermal capacity)

W = braking energy between two successive air gap adjustments

P_b = power drawn by brake at 20° (50 Hz)

s/h = starts per hour

NOTE

Values t₁ and t₂ in the table refer to a brake set at rated torque, medium air gap and rated voltage.

Legende:

M_b = statisches max. Bremsmoment (±15%)

t₁ = Bremsenansprechzeit

t₂ = Bremsverzögerung

W_{max} = max. Energie pro Bremsung (Wärmeleistung der Bremse)

W = Bremsenergie zwischen zwei Einstellungen des Luftspalts

P_b = bei 20° von der Bremse aufgenommene Leistung (50 Hz)

s/h = Einschaltungen pro stunde

HINWEIS:

Die in der Tabelle angegebenen Werte t₁ und t₂ beziehen sich auf eine Bremse, die auf das Nenn Drehmoment, einen mittleren Luftspalt und die Standardspannung eingestellt ist.

Légende:

M_b = couple de freinage statique max (±15%)

t₁ = temps de déblocage frein

t₂ = retard de freinage

W_{max} = énergie max par freinage (capacité thermique du frein)

W = énergie de freinage entre deux réglages successifs de l'entrefer

P_b = puissance absorbée par le frein à 20° (50 Hz)

s/h = démarrages horaires

N.B.

Les valeurs de t₁ et t₂ indiquées dans le tableau se réfèrent au frein étalonné au couple nominal, entrefer moyen et tension nominale.

Collegamenti freno FA

FA brake connections

Abschlüsse - Bremstyp FA

Raccordements frein FA

Per i motori con alimentazione del freno derivata direttamente dall'alimentazione motore i collegamenti alla morsetteria corrispondono a quanto riportato nello schema (A63):

The diagram (A63) shows the wiring when brake is connected directly to same power supply of the motor:

Bei den Motoren mit direkter Bremsspannungsversorgung müssen die Anschlüsse im Klemmenkasten entsprechend den Angaben im Schema (A63) angeschlossen werden:

Pour les moteurs avec alimentation du frein dérivant directement de l'alimentation moteur, les raccordements à la boîte à bornes correspondent aux indications du schéma (A63) :

(A63)

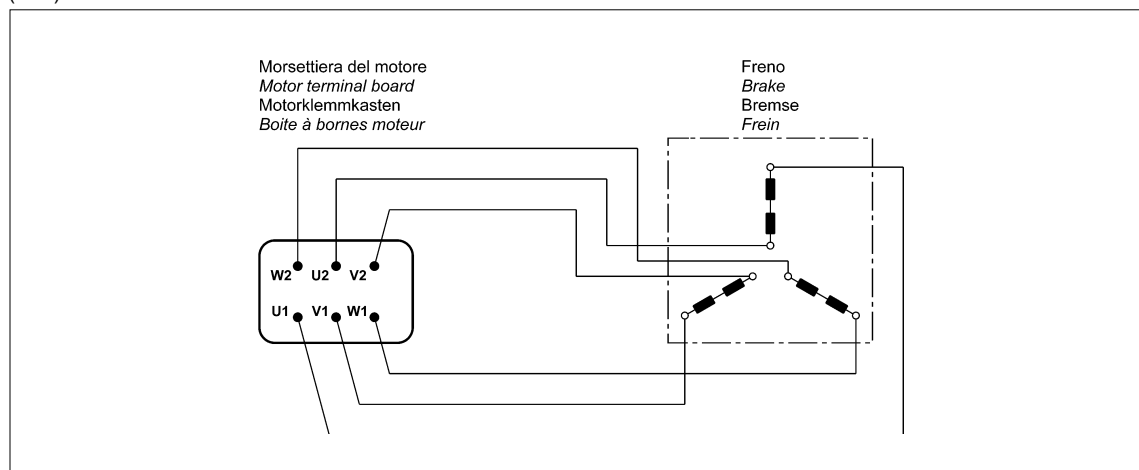

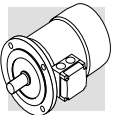

Per i motori a doppia polarità e, quando richiesto, per i motori ad una velocità con alimentazione da linea separata è prevista una morsettiere ausiliaria a 6 morsetti per il collegamento del freno; in questa esecuzione i motori prevedono la scatola copri-morsetti maggiorata. Vedi schema (A64):

Switch-pole motors and, at request, single-pole motors with separate power supply are equipped with an auxiliary terminal board with 6 terminals for brake connection. In this version, motors feature a larger terminal box. See diagram (A64):

Bei den polumschaltbaren Motoren und, auf Anfrage, auch bei den einpoligen Motoren mit separater Bremsversorgung ist für den Anschluss der Bremse ein Hilfsklemmenkasten mit 6 Klemmen vorgesehen. In diesen Ausführungen haben die Motoren einen größeren Klemmenkasten. Siehe Schema (A64):

Pour les moteurs à double polarité et, lorsque cela est requis, pour les moteurs à une vitesse avec alimentation depuis ligne séparée, une boîte à bornes auxiliaire à 6 bornes est prévue pour le raccordement du frein ; dans cette exécution les moteurs prévoient un couvercle bornier majoré. Voir schéma (A64) :

(A64)

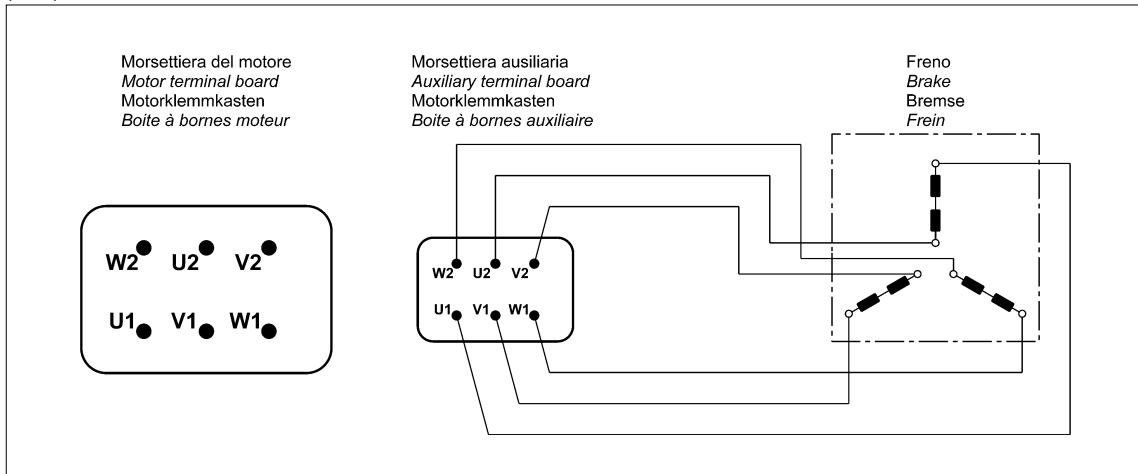

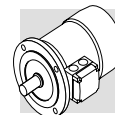

**M8 - MOTORI AUTOFRENANTI
IN C.A., TIPO BN_BA**

**M8 - AC BRAKE MOTORS
TYPE BN_BA**

**M8 - DREHSTROM-BREMS-
MOTOREN MIT WECH-
SELS- TROMBREMSE
VOM TYP BN_BA**

**M8 - MOTEURS FREIN EN C.A.,
TYPE BN_BA**

Grandezze: BN 63 ... BN 132M

Frame sizes: BN 63 ... BN 132M

Baugrößen: BN 63 ... BN 132M

Tailles : BN 63 ... BN 132M

(A65)

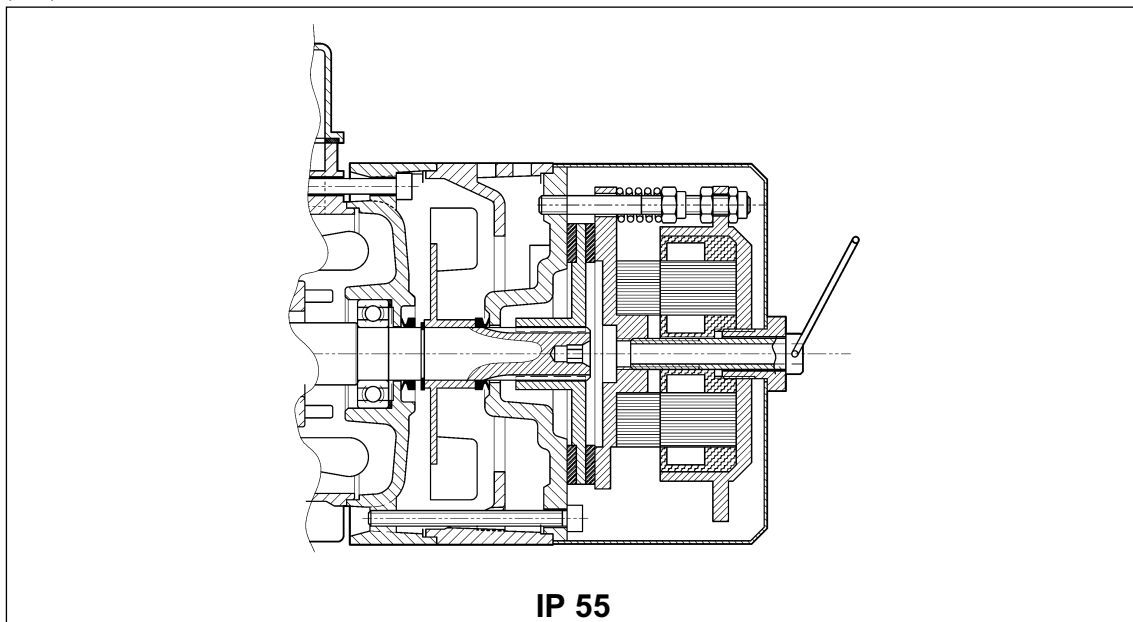

IP 55

Freno elettromagnetico con alimentazione in **corrente alternata** trifase, fissato con viti allo scudo convogliatore.

Disco freno in acciaio scorrevole assialmente sull'albero motore scanalato (mozzo trascinatore in acciaio calettato sull'albero per grandezza 244).

I motori sono forniti con freno tarato alla massima coppia.

La coppia freno è regolabile con continuità agendo sulle viti di compressione delle molle; il campo di regolazione consentito è $30\% M_{bMAX} < M_b < M_{bMAX}$ (M_{bMAX} è il momento frenante massimo riportato in tab. (A66)).

Di serie i motori sono forniti completi di vite per lo sblocco manuale del freno, con mantenimento della posizione di rilascio per consentire la rotazione dell'albero motore.

La vite di sblocco deve essere smontata dopo l'utilizzo per assicurare il corretto funzionamento del freno, ed evitare situazioni potenzialmente pericolose.

Il freno BA, oltre alle elevate caratteristiche dinamiche tipiche dei freni in corrente alternata, presenta una costruzione robusta con energia di frenatura aumentata che lo rendono particolarmente idoneo a servizi pesanti, oltre che in applicazioni dove sono richieste frequenze di manovra elevate e tempi d'intervento molto rapidi.

*Electromagnetic brake operates from three-phase **alternated current** power supply and is bolted onto conveyor shield.*

Steel brake disc slides axially on splined motor shaft (steel drive hub is shrunk onto shaft on frame size 244).

Factory setting is maximum brake torque.

Step less braking torque adjustment by screws which compress the brake springs. Allowed adjustment range is $30\% M_{bMAX} < M_b < M_{bMAX}$ (where M_{bMAX} is maximum braking torque as shown in tab. (A66)).

Motors are supplied complete with manual brake release screw as standard. Screw may be locked in the release position to allow for motor shaft rotation.

The brake release screw must be removed after use to ensure proper brake operation and avoid potentially dangerous conditions.

In addition to the high dynamic characteristics typical of AC brakes, a sturdy design and increased braking energy make the BA brake ideal for heavy-duty applications as well as applications requiring frequent stop/starts and very fast response time.

Elektromagnetische Bremse mit **Drehstromversorgung**, die mittels Schrauben am Motorschild des Motors befestigt ist.

Die Bremscheibe (Stahl) gleitet axial auf der Rotorwelle (bei Baugröße 244 über einem auf die Welle aufgezogenem Mitnehmer aus Stahl).

Die Motoren werden mit einer auf das maximale Drehmoment des Motors eingestellten Bremse geliefert.

Das Bremsdrehmoment ist durch Betätigen der Federdruckschrauben stufenlos regelbar. Der zulässige Einstellbereich beträgt $30\% M_{bMAX} < M_b < M_{bMAX}$ (M_{bMAX} steht für den max. Bremsmoment, das in der Tab. (A66) angegeben wird).

Die Motoren werden serienmäßig mit einer Schraube zur manuelle Bremslüftung geliefert; die arretierbar ist, um ein Drehen der Motorwelle zu ermöglichen.

Diese Schraube muss im Betrieb des Motors wieder abmontiert werden, damit die korrekte Funktion der Bremse gesichert ist.

Die Bremse vom Typ BA zeichnet sich durch ihre dynamischen Eigenschaften und die robuste Bauweise aus, durch die sie eine erhöhte Bremsenergie abzugeben kann. Diese Bremstypen eignen sich besonders für einen Einsatz unter harten Bedingungen und überall dort, wo häufige Schaltfrequenzen und schnelle Ansprechzeiten gefordert werden.

*Frein électromagnétique avec alimentation en **courant alternatif** triphasé, fixé avec des vis au bouclier.*

Disque frein en acier coulissant de façon axiale sur l'arbre moteur rainuré (moyeu d'entraînement en acier calé sur l'arbre pour la taille 244).

Les moteurs sont fournis avec frein étalonné au couple maximal.

Le couple de freinage est réglable en continu en intervenant sur les vis de compression des ressorts ; la plage de réglage autorisé est de $30\% M_{bMAX} < M_b < M_{bMAX}$ (M_{bMAX} étant le couple de freinage maximum indiqué dans le tab. (A66)).

De série, les moteurs sont fournis avec vis de déblocage manuel du frein, avec maintien de la position de relâchement afin de permettre la rotation de l'arbre moteur.

La vis de déblocage doit être démontée après utilisation afin de garantir le fonctionnement correct du frein et d'éviter les situations potentiellement dangereuses.

Le frein BA, outre les caractéristiques dynamiques élevées typiques des freins en courant alternatif, est de fabrication robuste avec énergie de freinage majeure, ce qui le rend particulièrement adapté pour les services difficiles ainsi que pour les applications nécessitant des fréquences de manœuvre élevées et des temps d'intervention très rapides.

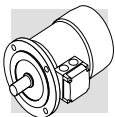

Grado di protezione

È disponibile un'unica esecuzione, con grado di protezione IP55.

Protection class

Only available in protection class IP55.

Schutzart

Es ist eine nur die Ausführung in Schutzklasse IP55 verfügbar.

Degré de protection

Il est disponible en une exécution unique, avec degré de protection IP55.

Alimentazione freno BA

Nei motori a singola polarità l'alimentazione della bobina freno è derivata direttamente dalla morsettiera motore e la tensione del freno quindi coincide con la tensione del motore. In questo caso la tensione del freno può essere omessa dalla designazione.

Per i motori a doppia polarità, e per i motori con alimentazione separata del freno, è presente una morsettiera ausiliaria con 6 terminali per il collegamento alla linea del freno. In entrambi i casi il valore di tensione del freno dovrà essere specificato in designazione.

Nella tabella seguente sono riportate le condizioni di alimentazione standard del freno in c.a. per i motori a singola e doppia polarità:

BA brake power supply

In single-pole motors, power supply is brought to the brake coil direct from the motor terminal box. As a result, brake voltage and motor voltage are the same. In this case, brake voltage indication may be omitted in the designation.

Switch-pole motors and motors with separate brake power supply feature an auxiliary terminal board with 6 terminals for connection to brake line. In both cases, brake voltage indication in the designation is mandatory. The following table reports standard AC brake power supply ratings for single- and switch-pole motors:

Stromversorgung - Bremstyp BA

Bei den einpoligen Motoren wird die Versorgung der Bremsspule direkt vom Motorklemmenkasten abgezweigt, das bedeutet also, dass die Spannung der Bremse mit der Motorspannung übereinstimmt. In diesem Fall braucht die Bremsenspannung nicht extra angegeben werden.

Für polumschaltbaren Motoren und für eine separate Bremsversorgung ist eine Hilfsklemmenleiste mit 6 Anschlüssen vorgesehen, die einen Anschluss der Bremse ermöglichen. In beiden Fällen muss die Bremsenspannung bei der Bestellung angegeben werden.

In der nachstehenden Tabelle werden für die einpoligen und die polumschaltbaren Motoren die Standardversorgung der Wechselstrombremsen angegeben.

Alimentation frein BA

Sur les moteurs à simple polarité, l'alimentation de la bobine frein dérive directement du bornier moteur, par conséquent, la tension du frein coïncide avec la tension du moteur. Dans ce cas, la tension du frein peut être omise de la désignation.

Pour les moteurs à double polarité et les moteurs avec alimentation séparée du frein, un boîte à bornes auxiliaire avec 6 bornes pour le raccordement au réseau du frein, est présente. Dans les deux cas, la valeur de tension du frein doit être spécifiée dans la désignation.

Le tableau suivant indique les conditions d'alimentation standard du frein en c.a. pour les moteurs à simple et double polarité :

(A65)

motori a singola polarità single-pole motor Einpolige Motoren Moteurs à simple polarité	BN 63 ... BN 132
	230Δ / 400Y V ±10% – 50 Hz
	265Δ / 460Y ±10% - 60 Hz
motori a doppia polarità (alimentazione da linea separata) switch-pole motors (separate power supply line) Polumschaltbare Motoren (separate Versorgung) Moteurs à double polarité (alimentation depuis ligne séparée)	BN 63 ... BN 132
	230Δ / 400Y V ±10% – 50 Hz
	460Y - 60 Hz

Se non diversamente specificato, l'alimentazione standard del freno è 230Δ /400Y V - 50 Hz.

Unless otherwise specified, standard brake power supply is 230Δ /400Y V - 50 Hz.

Falls nicht anderweitig angegeben, beträgt die Standardversorgung der Bremse 230Δ /400Y V - 50 Hz.

Sauf spécification contraire, l'alimentation standard du frein est 230Δ /400Y V - 50 Hz.

Su richiesta, sono disponibili tensioni speciali, nel campo 24...690 V, 50-60 Hz.

Special voltages in the 24...690 V, 50-60 Hz range are available at request.

Auf Anfrage können Sonderspannungen von 24...690 V, 50-60 Hz geliefert werden.

Sur demande, des tensions spéciales sont disponibles dans la plage 24...690 V, 50-60 Hz.

Dati tecnici freni BA

Nella tabella (A66) sottostante sono riportati i dati tecnici dei freni in c.a., tipo BA.

BA brake technical specifications

The table (A66) below reports the technical specifications for AC brakes type BA.

Technische Daten der Bremsen vom Typ BA

In der nachstehenden Tabelle (A66) werden die technischen Daten der Wechselstrombremsen vom Typ BA angegeben:

Caractéristiques techniques freins BA

Le tableau (A66) ci-dessous indique les caractéristiques techniques des freins en c.a., type BA.

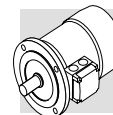

(A66)

Freno Brake Brems Frein	Coppia frenante Brake torque Bremsmoment Couple de freinage	Rilascio Release Ansprechzeit Déblocage	Frenatura Braking Bremsung Freinage	W _{max}			W	P _b
				[J]				
				10 s/h	100 s/h	1000 s/h		
	M _b [Nm]	t ₁ [ms]	t ₂ [ms]				[MJ]	[VA]
BA 60	5	5	20	4000	1500	180	30	60
BA 70	8	6	25	7000	2700	300	60	75
BA 80	18	6	25	10000	3100	350	80	110
BA 90	35	8	35	13000	3600	400	88	185
BA 100	50	8	35	18000	4500	500	112	225
BA 110	75	8	35	28000	6800	750	132	270
BA 140	150	15	60	60000	14000	1500	240	530

Legenda:

M_b = max coppia frenante statica (±15%)

t₁ = tempo di rilascio freno

t₂ = ritardo di frenatura

W_{max} = energia max per frenata (capacità termica del freno)

W = energia di frenatura tra due regolazioni successive del traferro

P_b = potenza assorbita dal freno a 20° (50 Hz)

s/h = avviamenti orari

N.B.

I valori di t₁ e t₂ riportati in tabella sono riferiti al freno tarato alla coppia nominale, traferro medio e tensione nominale.

Key:

M_b = max static braking torque (±15%)

t₁ = brake release time

t₂ = brake engagement time

W_{max} = max energy per brake operation (brake thermal capacity)

W = braking energy between two successive air gap adjustments

P_b = brake power absorption at 20° (50 Hz)

s/h = starts per hour

NOTE

Values t₁ and t₂ in the table refer to a brake set at rated torque, medium air gap and rated voltage.

Legende:

M_b = statisches max. Bremsmoment (±15%)

t₁ = Bremsenansprechzeit

t₂ = Bremsverzögerung

W_{max} = max. Energie pro Bremsung (Wärmeleistung der Bremse)

W = Bremsenergie zwischen zwei Einstellungen des Luftspalts

P_b = bei 20° von der Bremse aufgenommene Leistung (50 Hz)

s/h = Einschaltungen pro stunde

HINWEIS:

Die in der Tabelle angegebenen Werte t₁ und t₂ beziehen sich auf eine Bremse, die auf das Nenndrehmoment, einen mittleren Luftspalt und die Standardspannung eingestellt ist.

Légende:

M_b = couple de freinage statique max (±15%)

t₁ = temps de déblocage frein

t₂ = retard de freinage

W_{max} = énergie max par freinage (capacité thermique du frein)

W = énergie de freinage entre deux réglages successifs de l'entrefer

P_b = puissance absorbée par le frein à 20° (50 Hz)

s/h = démarrages horaires

N.B.

Les valeurs de t₁ et t₂ indiquées dans le tableau se réfèrent au frein étalonné au couple nominal, entrefer moyen et tension nominale.

Collegamenti freno BA

Per i motori con alimentazione del freno derivata direttamente dall'alimentazione motore i collegamenti alla morsettiera corrispondono a quanto riportato nello schema (A67):

BA brake connections

The diagram (A67) shows the required connections to terminal box when brake is to be connected directly to motor power supply:

Abschlüsse - Bremstyp BA

Bei den Motoren mit direkter Bremsspannungsversorgung müssen die Anschlüsse im Klemmenkasten entsprechend den Angaben im Schema (A67) angeschlossen werden:

Raccordements frein BA

Pour les moteurs avec alimentation du frein dérivant directement de l'alimentation moteur, les raccordements à la boîte à bornes correspondent aux indications du schéma (A67) :

(A67)

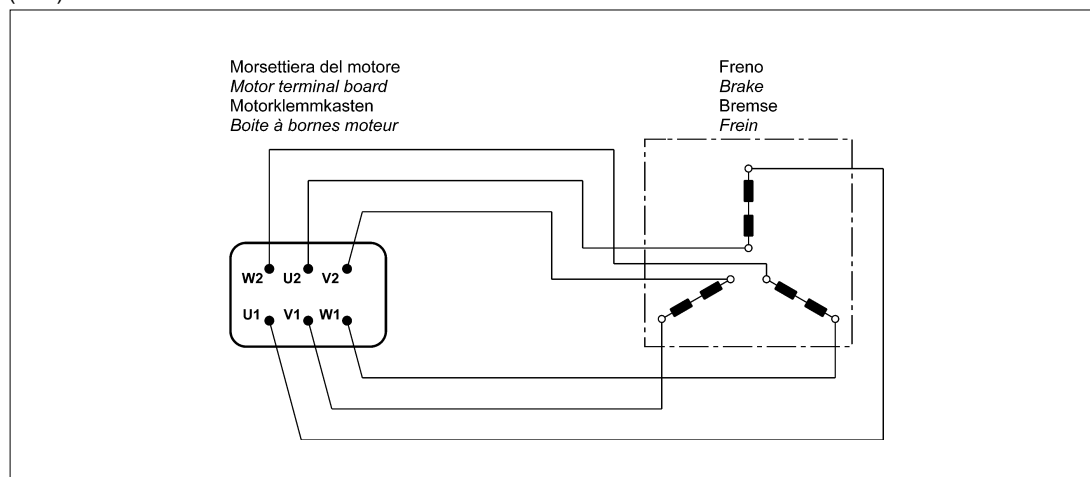

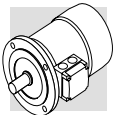

Per i motori a doppia polarità e, quando richiesto, per i motori ad una velocità con alimentazione da linea separata è prevista una morsettiera ausiliaria a 6 morsetti per il collegamento del freno; in questa esecuzione i motori prevedono la scatola copri-morsetti maggiorata. Vedi schema (A68):

Switch-pole motors and, at request, single-pole motors with separate power supply line are equipped with an auxiliary terminal board with 6 terminals for brake connection. In this version, motors feature a larger terminal box. See diagram (A68):

Bei den polumschaltbaren Motoren und, auf Anfrage, auch bei den einpoligen Motoren mit separater Bremsversorgung ist für den Anschluss der Bremse ein Hilfsklemmenkasten mit 6 Klemmen vorgesehen. In diesen Ausführungen haben die Motoren einen größeren Klemmenkasten. Siehe Schema (A68):

Pour les moteurs à double polarité et, lorsque cela est requis, pour les moteurs à une vitesse avec alimentation depuis ligne séparée, une boîte à bornes auxiliaire à 6 bornes est prévue pour le raccordement du frein ; dans cette exécution les moteurs prévoient un couvercle bornier majoré. Voir schéma (A68) :

(A68)

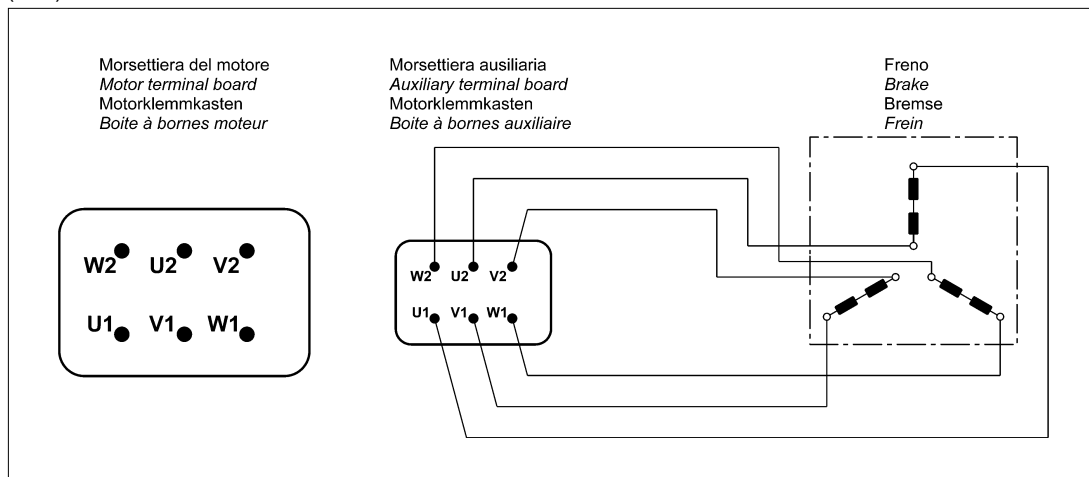

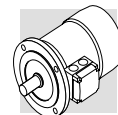

M9 - SISTEMI DI SBLOCCO FRENO

I freni a pressione di molle tipo **FD** e **FA** possono essere dotati opzionalmente di dispositivi per lo sblocco manuale del freno, normalmente utilizzati per condurre interventi di manutenzione sulle parti di macchina, o dell'impianto, comandate dal motore.

M9 - BRAKE RELEASE SYSTEMS

*Spring-applied brakes type **FD** and **FA** may be equipped with optional manual release devices. These are typically used for manually releasing the brake before servicing any machine or plant parts operated by the motor.*

M9 - BREMSLÜFTHEBEL

Die Federdruckbremsen vom Typ **FD** und **FA** können Optional mit Bremslüfthebeln geliefert werden, die ein manuelles Lüften der Bremse ermöglichen. Diese Lüftungseinrichtungen können bei Instandhaltungsarbeiten an vom Motor betriebenen Maschinen- oder Anlagenteilen verwendet werden.

M9 - SYSTEMES DE DEBLOCAGE FREIN

*Les freins à pression de ressorts type **FD** et **FA** peuvent, en option, être dotés de dispositifs de déblocage manuel du frein, normalement utilisés pour effectuer des interventions d'entretien sur les composants de la machine, ou de l'installation commandée par le moteur.*

(A69)

R

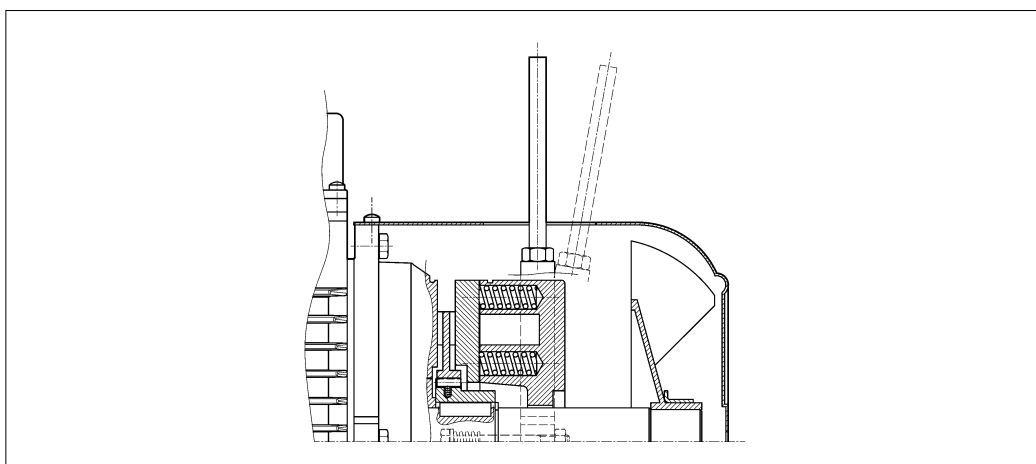

La leva di sblocco è dotata di ritorno automatico, tramite dispositivo a molla.

A return spring brings the release lever back in the original position.

Bremslüfthebel mit automatischer Rückstellung durch Federkraft.

Le levier de déblocage est doté de retour automatique, au moyen d'un dispositif à ressort.

(A70)

RM

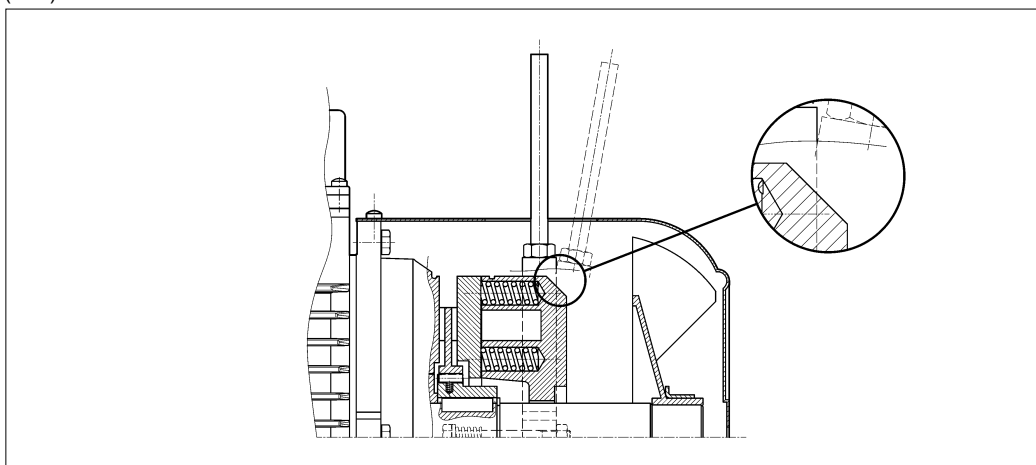

Sui motori tipo BN_FD la leva di sblocco può essere temporaneamente bloccata in posizione di rilascio del freno, avvitando la stessa fino ad impegnarne l'estremità in un risalto del corpo del freno.

On motors type BN_FD, if the option RM is specified, the release device may be locked in the "release" position by tightening the lever until its end becomes engaged with a brake housing projection.

Der Bremslüfthebel kann zeitweise in der Bremslüfthebel position arretiert werden, indem man ihn so lange einschraubt, bis die Bremse arretiert ist. Für die unterschiedlichen Motor-

Levier de déblocage peut être temporairement bloqué en position de déblocage du frein en le vissant jusqu'à engager l'extrémité dans une saillie du corps du frein. La disponibilité des systèmes de

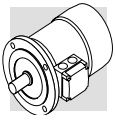

La disponibilità dei sistemi di sblocco freno è diversa per i vari tipi di motore, ed è descritta dalla tabella seguente:

The availability for the various disengagement devices is charted here below:

typen sind ebenso verschiedene Bremslüftsysteme verfügbar, die Sie der folgenden Tabelle entnehmen können:

débloccage du frein est différente en fonction des types de moteur et figure dans le tableau suivant :

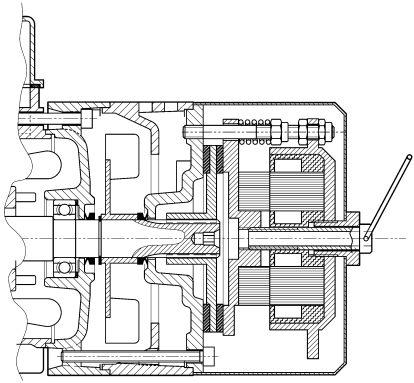
(A71)	R	RM
BN_FD	BN 63...BN 200	2p 63A2 ≤ H ≤ 132M2 4p 63A4 ≤ H ≤ 132MA4 6p 63A6 ≤ H ≤ 132MA6
M_FD	M 05...M 5	M 05...M 4LA
BN_FA	BN 63...BN 180M	
M_FA	M 05...M 5	
BN_BA	 <p>di serie std. supply serienmäßig de série</p>	

Orientamento della leva di sblocco

Release lever orientation

Ausrichtung des Bremslüfthebels

Orientation du levier de déblocage

Per entrambe le opzioni **R** e **RM**, la leva di sblocco del freno viene collocata, se non diversamente specificato, con orientamento di 90° in senso orario, rispetto alla posizione della morsettiera - riferimento **[AB]** nel disegno sottostante. Orientamenti alternativi, tipo **[AA]**, **[AC]** e **[AD]** possono essere richiesti citandone la relativa specifica:

Unless otherwise specified, the release lever is located 90° away from the terminal box – identified by letters **[AB]** in the diagram below – in a clockwise direction on both options **R** and **RM**. Alternative lever positions **[AA]**, **[AC]** and **[AD]** are also possible when the corresponding option is specified:

Bei beiden Optionen, **R** und **RM**, wird der Bremslüfthebel, falls nicht anderweitig festgelegt, um 90° im Uhrzeigersinn zur Position des Klemmenkastens montiert (Position **[AB]** in der nachfolgenden Zeichnung). Andere Positionen: **AA** (0° zum Klemmenkasten), **AC** (180° zum Klemmenkasten) oder **AD** (270° zum Klemmenkasten, im Uhrzeigersinn vom Lüfter aus gesehen) können unter Angabe der entsprechenden Spezifikation bestellt werden:

Pour les deux options **R** et **RM**, le levier de déblocage du frein est positionné, sauf spécification contraire, avec une orientation de 90° dans le sens des aiguilles d'une montre par rapport à la position de la boîte à bornes - référence **[AB]** sur le dessin ci-dessous. Des orientations différentes, type **[AA]**, **[AC]** et **[AD]** peuvent être demandées à condition de préciser la position correspondante :

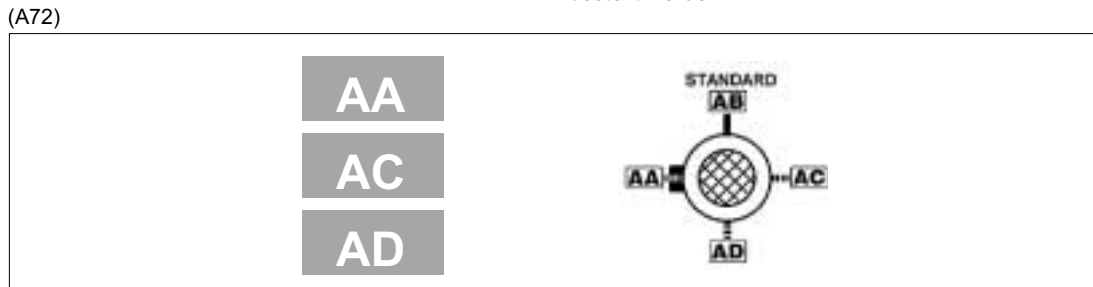

Caratteristiche volani (F1)

Fly-wheel data (F1)

Eigenschaften der Schwungräder (F1)

Caractéristiques volants (F1)

La tabella seguente riporta il peso e l'inerzia aggiuntiva dei volani che possono essere richiesti tramite l'opzione F1. Le dimensioni complessive rimangono invariate.



The table below shows values of weight and inertia of flywheel (option F1). Overall dimensions of motors remain unchanged.

Die folgende Tabelle gibt das Gewicht und das Trägheitsmoment der Zusatzschwungräder an (Option F1). Die Gesamtmaße bleiben unverändert.

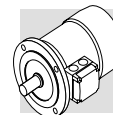
Le tableau suivante indique le poids et l'inertie des volants supplémentaires sans variations de l'encombrement moteur.



(A73)

Dati tecnici volano per motori tipo: / Main data for flywheel of motore type: / Eigenschaften der Schwungräder für Motoren typ: / Données volant pour moteurs type: BN_FD, M_FD			
		Peso volano / Fly-wheel weight Gewicht Schwungrad / Poids volant [Kg]	Inerzia volano / Fly-wheel inertia Trägheitsmoment Schwungrad / Inertie volant [Kgm ²]
BN 63	M05	0.69	0.00063
BN 71	M1	1.13	0.00135
BN 80	M2	1.67	0.00270
BN 90 S - BN 90 L	–	2.51	0.00530
BN 100	M3	3.48	0.00840
BN 112	–	4.82	0.01483
BN 132 S - BN 132 M	M4	6.19	0.02580

M10 - OPZIONI**M10 - OPTIONS****M10 - OPTIONEN****M10 - OPTIONS****Protezioni termiche****Thermal protective devices****Thermische Schutzeinrichtungen****Protections thermiques**

Oltre alla protezione garantita dall'interruttore magnetotermico, i motori possono essere provvisti di sonde termiche incorporate per proteggere l'avvolgimento da eccessivo riscaldamento dovuto a scarsa ventilazione o servizio intermittente. Questa protezione dovrebbe sempre essere prevista per motori servoventilati (IC416).

In addition to the standard protection provided by the magneto-thermal device, motors can be supplied with built-in thermal probes to protect the winding against overheating caused, by insufficient ventilation or by an intermittent duty. This additional protection should always be specified for servoventilated motors (IC416).

Abgesehen von den Motorschutzschaltern mit thermischem und elektromagnetischem Auslöser können die Motoren mit integrierten Temperaturfühlern zum Schutz der Wicklung vor Überhitzung z.B. wegen unzureichender Lüftung oder Aussetzbetriebs ausgestattet werden. Diese Schutzeinrichtung muß bei fremdbelüfteten Motoren stets vorgesehen werden (IC416).

Outre la protection garantie par l'interrupteur magnétothermique, les moteurs peuvent être équipés de sondes thermiques incorporées pour protéger le bobinage contre une surchauffe excessive due par exemple à une ventilation insuffisante ou un service intermittent. Cette protection devrait toujours être prévue pour les moteurs servoventilés (IC416).

E3**Sonde termiche a termistori****Thermistors****Temperaturfühler und Thermistoren****Sondes thermométriques**

Sono dei semiconduttori che presentano una rapida variazione di resistenza in prossimità della temperatura nominale di intervento.

These are semi-conductors having rapid resistance variation when they are close to the rated switch off temperature.

Hierbei handelt es sich um Halbleiter, die eine schnelle Änderung des Widerstands in der Nähe der Nennansprechtemperatur zeigen.

Ce sont des semiconducteurs qui présentent une variation rapide de résistance à proximité de la température nominale d'intervention.

L'andamento della caratteristica $R = f(T)$ è normalizzato dalle Norme DIN 44081, IEC 34-11. Questi sensori presentano il vantaggio di avere ingombri ridotti, un tempo di risposta molto contenuto e, dato che il funzionamento avviene senza contatti, sono completamente esenti da usura.

Variations of the $R = f(T)$ characteristic are specified under DIN 44081, IEC 34-11 Standards.

Der Verlauf der Kennlinie $R = f(T)$ ist durch die DIN-Normen 44081 und IEC 34-11 festgelegt. Diese Sensoren haben folgende Vorteile: sie weisen geringe Außenmaße und eine äußerst kurze Ansprechzeit auf und sind vollkommen verschleißfrei, da sie berührungslos arbeiten. Im allgemeinen werden Thermistoren mit positivem Temperaturkoeffizienten verwendet, die auch als "Kaltleiter" (PTC-Widerstände) bezeichnet werden.

L'évolution de la caractéristique $R = f(T)$ est défini par les Normes DIN 44081, IEC 34-11.

In genere vengono impiegati termistori a coefficiente di temperatura positivo denominati anche "resistori a conduttore freddo" PTC.

These elements feature several advantages: compact dimensions, rapid response time and, being contact-free, absolutely no wear.

Im Unterschied zu Bimetall-Temperaturfühlern können sie nicht direkt auf die Erregungsströme der Spulen wirken, sondern müssen an eine spezielle Steuereinheit (Auslösegerät) angeschlossen werden, die mit den externen Anschlüssen kompatibel ist.

Ces capteurs présentent l'avantage d'avoir des encombrements réduits, un temps de réponse très bref et, du fait que le fonctionnement a lieu sans contact, il sont exempts d'usure. En général, on utilise des thermistors à coefficient de température positif dénommés également "résistors à conducteur froid" PTC.

A differenza delle sonde termiche bimetalliche, non possono intervenire direttamente sulle correnti delle bobine di eccitazione e devono pertanto essere collegati ad una speciale unità di controllo (apparecchio di sgancio) da interfacciare alle connessioni esterne.

Positive temperature coefficient thermistors are normally used (also known as PTC "cold conductor resistors"). Contrary to bimetallic thermostats, they cannot directly intervene on currents of energizing coils, and must therefore be connected to a special control unit (triggering apparatus) to be interfaced with the external connections.

Mit dieser Schutzeinrichtung werden drei in Reihe geschaltete PTC-Widerstände in die Wicklung eingesetzt, deren Endanschlüsse an einer Zusatzklemmleiste verfügbar sind.

Contrairement aux sondes thermiques bimétalliques, ils ne peuvent intervenir directement sur les courants des bobines d'excitation et doivent par conséquent être reliés à une unité spéciale de contrôle (appareil de déconnexion) à interfacer aux connexions extérieures.

Con questa protezione vengono inseriti tre PTC, (collegati in serie), nell'avvolgimento con terminali disponibili in morsetti ausiliaria.

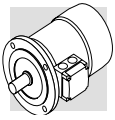

D3

Sonde termiche bimetalliche

I protettori di questo tipo contengono all'interno di un involucro un disco bimetallico che, raggiunta la temperatura nominale di intervento, commuta i contatti dalla posizione di riposo. Con la diminuzione della temperatura, il disco e i contatti riprendono automaticamente la posizione di riposo. Normalmente si impiegano tre sonde bimetalliche in serie con contatti normalmente chiusi e terminali disponibili in una morsettiere ausiliaria.

Bimetallic thermostates

These types of protective devices house a bimetal disk. When the rated switch off temperature is reached, the disk switches the contacts from their initial rest position. As temperature falls, the disk and the contacts automatically return to rest position. Three bimetallic thermostates connected in series are usually employed, with normally closed contacts. The terminals are located on an auxiliary terminal-board.

Bimetal-Temperaturfühler

Diese Schutzeinrichtungen bestehen aus einer Kapsel, in der sich eine Bimetallscheibe befindet, die bei Erreichen der Nennansprechtemperatur anspricht. Nach Absenkung der Temperatur geht der Schaltkontakt automatisch in Ruhestellung zurück. Normalerweise werden drei in Reihe geschaltete Bimetallfühler mit Öffnern verwendet, deren Endverschlüsse an einer Zusatzklemmleiste verfügbar sind.

Sondes thermiques biméalliques

Les protecteurs de ce type contiennent, dans une enveloppe interne, un disque bimétallique qui, lorsque la température nominale d'intervention est atteinte, commute les contacts de la position de repos. Avec la diminution de la température, le disque et les contacts reprennent automatiquement la position de repos. Normalement, on utilise trois sondes biméalliques en série avec contacts normalement fermés et extrémités disponibles dans un bornier auxiliaire.

H1

Riscaldatori anticondensa

I motori funzionanti in ambienti molto umidi e/o in presenza di forti escursioni termiche, possono essere equipaggiati con una resistenza anti-condensa. L'alimentazione monofase è prevista da morsettiere ausiliaria posta nella scatola principale. Le potenze assorbite dalla resistenza elettrica sono elencate qui di seguito:

Anti-condensation heaters

Where an application involves high humidity or extreme temperature fluctuation, motors may be equipped with an anti-condensate heater. A single-phase power supply is available in the auxiliary terminal board inside the main terminal box. Values for the absorbed power are listed here below:



Wicklungsheizung

Die Motoren, die in besonders feuchten Umgebungen und/oder unter starken Temperaturschwankungen eingesetzt werden, können mit einem Heizelement als Kondenswasserschutz ausgestattet werden. Die einphasige Versorgung erfolgt über eine Zusatzklemmleiste, die sich im Klemmenkasten befindet. Werte fuer die Leistungsaufnahme sind in folgender Tabelle aufgeführt.

Rechauffeurs anticondensation

Les moteurs fonctionnant dans des milieux très humides et/ou en présence de fortes plages thermiques peuvent être équipés d'une résistance anticondensation. L'alimentation monophasée est prévue par l'intermédiaire d'une boîte à bornes auxiliaire située dans la boîte principale. Les puissances absorbées sont indiqués de suite :

(A74)

		H1
		1~ 230V ± 10%
		P [W]
BN 56...BN 80	M0...M2	10
BN 90...BN 160MR	M3 - M4	25
BN 160M...BN 180M	M5	50
BN 180L...BN 200L	—	65

Importante!
Durante il funzionamento del motore la resistenza anticondensa non deve mai essere inserita.

Warning!
Always remove power supply to the anti-condensate heater before operating the motor.

Warnung!
Während des Motorbetriebs darf die Wicklungsheizung nie gespeist werden.

Avertissement!
Durant le fontionnement du moteur, la résistance anticondensation ne doit jamais être alimentée.

PS

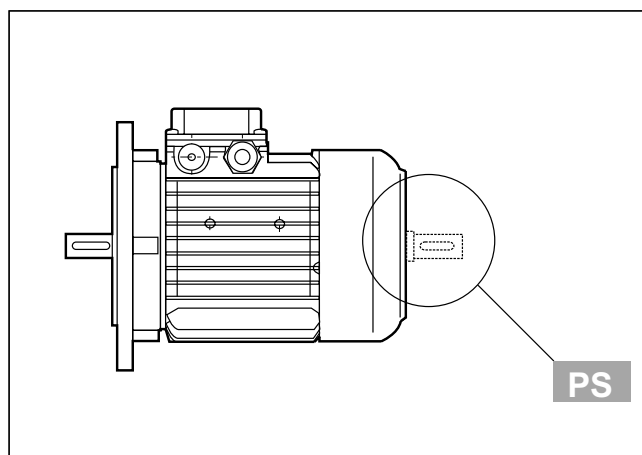

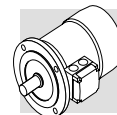

Seconda estremità d'albero

L'opzione esclude le varianti RC, TC, U1, U2, EN1, EN2, EN3 – non applicabile ai motori con freno tipo BA. Le dimensioni sono reperibili nelle tavole dimensionali dei motori.

Second shaft extension

This option is not compatible with variants RC, TC, U1, U2, EN1, EN2, EN3 – and is not feasible on motors equipped with BA brake. For shaft dimensions please see motor dimensions tables.

Zweites Wellenende

Diese Option schließt die Optionen RC, TC, U1, U2, EN1, EN2, EN3 aus – sie kann nicht außerdem nicht an Motoren, die mit einer Bremse vom Typ BA ausgestattet sind, angebaut werden. Die entsprechenden Maße können den Maßtabellen der Motoren entnommen werden.

Arbre à double extrémité

L'option exclut les variantes RC, TC, U1, U2, EN1, EN2, EN3 – non applicables aux moteurs avec frein type BA. Les dimensions figurent sur les planches de dimensions des moteurs.

AL

AR

Dispositivo antiritorno

Nelle applicazioni dove è necessario impedire la rotazione inversa del motore dovuta all'azione del carico, è possibile impiegare motori provvisti di un dispositivo antiritorno (disponibile solo sulla serie M). Questo dispositivo, pur consentendo la libera rotazione nel senso di marcia, interviene istantaneamente in caso di mancanza di alimentazione bloccando la rotazione dell'albero nel senso inverso.

Il dispositivo antiritorno è lubrificato a vita con grasso specifico per questa applicazione.

In fase di ordine dovrà essere indicato chiaramente il senso di marcia previsto.

In nessun caso il dispositivo antiritorno dovrà essere utilizzato per impedire la rotazione inversa nel caso di collegamento elettrico errato.

Nella tabella (A75) sono indicate le coppie nominale e massima di bloccaggio attribuite ai dispositivi antiritorno utilizzati, mentre la raffigurazione schematica del dispositivo è inserita nella tabella (A76).

Le dimensioni sono le stesse del motore autofrenante.

Backstop device

For applications where backdriving must be avoided, motors equipped with an anti run-back device can be used (available for the M series only). While allowing rotation in the direction required, this device operates instantaneously in case of a power failure, preventing the shaft from running back.

The anti run-back device is life lubricated with special grease for this specific application.

When ordering, customers should indicate the required rotation direction, AL or AR.

Never use the anti run-back device to prevent reverse rotation caused by faulty electrical connection.

Table (A75) shows rated and maximum locking torques for the anti run-back devices.

A diagram of the device can be seen in Table (A76).

Overall dimensions are same as the corresponding brake motor.

Rücklaufsperre

Für Anwendungen, bei denen ein durch die Last verursachtes Rücklaufen des Motors verhindert werden soll, können Motoren installiert werden, die über eine Rücklaufsperre verfügen (nur bei Serie M verfügbar).

Diese Vorrichtung, die eine völlig unbehinderte Drehung des Motors in Laufrichtung gestattet, greift sofort ein, wenn die Spannung fehlt, und verhindert die Drehung der Welle in die Gegenrichtung.

Die Rücklaufsperre verfügt über eine Dauer - Schmierung mit einem speziell für diese Anwendung geeigneten Fett.

Bei der Bestellung muß die vorgesehene Drehrichtung des Motors genau angegeben werden.

Die Rücklaufsperre darf keinesfalls verwendet werden, um im Falle eines fehlerhaften elektrischen Anschlusses die Drehung in die Gegenrichtung zu verhindern. In Tabelle (A75) sind die Nenndrehmomente und Höchstdrehmomente für die verwendeten Rücklaufsperren angegeben; Abbildung (A76) zeigt eine schematische Darstellung der Vorrichtung.

Die abmessungen sind ähnlich denen der Bremsmotoren.

Dispositif anti-retour

Pour les applications où il est nécessaire d'empêcher la rotation inverse du moteur à cause de l'action de la charge, il est possible d'utiliser des moteurs dotés d'un dispositif anti-retour (disponible seulement sur la série M).

Ce dispositif, bien que permettant la libre rotation dans le sens de marche, intervient instantanément en cas de manque d'alimentation en bloquant la rotation de l'arbre dans le sens inverse. Le dispositif anti-retour est lubrifié à vie avec une graisse spécifique pour cette application.

En phase de commande, il faudra indiquer clairement le sens de marche prévu. En aucun cas, le dispositif anti-retour ne devra être utilisé pour empêcher la rotation inverse en cas de branchement électrique erroné.

Le tableau (A75) indique le couple nominal et le couple maximum de blocage attribués aux dispositifs anti-retour utilisés alors que la représentation schématique du dispositif se trouve dans le tableau (A76).

Les dimensions sont le même du moteur frein.

(A75)

	Coppia nominale di bloccaggio <i>Rated locking torque</i> Nenndrehmoment der Sperre <i>Couple nominal de blocage</i>	Coppia max. di bloccaggio <i>Max. locking torque</i> Max. Drehmoment der Sperre <i>Couple maxi. de blocage</i>	Velocità di distacco <i>Release speed</i> Ausrückgeschwindigkeit <i>Vitesse de décollement</i>
	[Nm]	[Nm]	[min ⁻¹]
M1	6	10	750
M2	16	27	650
M3	54	92	520
M4	110	205	430

(A76)

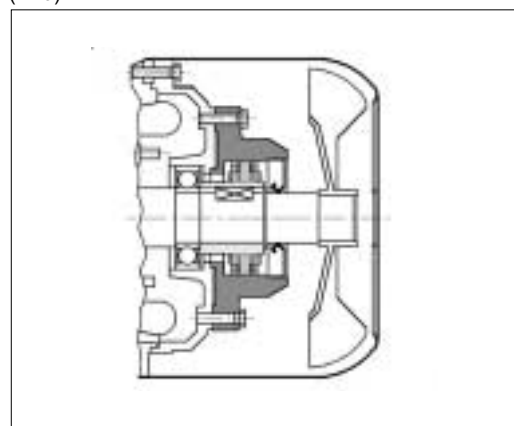

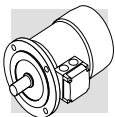

Ventilazione

I motori sono raffreddati mediante ventilazione esterna (IC 411 secondo CEI EN 60034-6) e sono provvisti di ventola radiale in plastica, funzionante in entrambi i versi di rotazione.

L'installazione dovrà assicurare una distanza minima della calotta copriventola dalla parete più vicina, in modo da non creare impedimento alla circolazione dell'aria, oltre che permettere l'esecuzione della manutenzione ordinaria del motore e, se presente, del freno.

Su richiesta, a partire dalle grandezze BN 71, oppure M1, i motori possono essere forniti con ventilazione forzata ad alimentazione indipendente. Il raffreddamento è realizzato per mezzo di un ventilatore assiale con alimentazione indipendente, montato sulla calotta copriventola (metodo di raffreddamento IC 416).

Questa esecuzione è utilizzata in caso di alimentazione del motore tramite inverter allo scopo di estendere il campo di funzionamento a coppia costante anche a bassa velocità, o quando per lo stesso sono richieste elevate frequenze di avviamento.

Da questa opzione sono esclusi i motori autofrenanti tipo BN_BA e tutti i motori con doppia sporgenza d'albero (opzione PS).

Ventilation

Motors are cooled through outer air blow (IC 411 according to CEI EN 60034-6) and are equipped with a plastic radial fan, which operates in both directions. Ensure that fan cover is installed at a suitable distance from the closest wall so to allow air circulation and servicing of motor and brake, if fitted.

On request, motors can be supplied with independently power-supplied forced ventilation system starting from BN 71 or M1 size. Motor is cooled by an axial fan with independent power supply and fitted on the fan cover (IC 416 cooling system).

This version is used in case of motor driven by inverter so that steady torque operation is possible even at low speed or when high starting frequencies are needed.

Brake motors of BN_BA type and all motors with rear shaft projection (PS option) are excluded.

Belüftung

Die Motoren werden mittels Fremdbelüftung gekühlt (IC 411 gemäß CEI EN 60034-6) und sind mit einem Radiallüfterrad aus Kunststoff ausgestattet, das in beide Richtungen dreht.

Die Installation muss zwischen Lüfterradkappe und der nächstliegenden Wand einen Mindestabstand berücksichtigen, so dass der Luftumlauf nicht behindert werden kann. Dieser Abstand ist jedoch ebenso für die regelmäßige Instandhaltung des Motors und, falls vorhanden, der Bremse erforderlich.

Ab der Baugröße BN 71 oder M1 können die Motoren auf Anfrage mit einer unabhängig gespeisten Zwangsbelüftung geliefert werden. Die Kühlung erfolgt hierdurch einen unabhängig gespeisten Axialventilator, der auf die Lüfterradkappe (Kühlmethode IC 416) montiert wird.

Diese Ausführung wird im Fall eines über einen Frequenzumrichter versorgten Motor verwendet, so dass der Betriebsbereich bei konstantem Drehmoment auch auf die niedrige Drehzahl ausgedehnt wird, oder im Fall von hohen Anlauffrequenzen.

Von dieser Option ausgeschlossen sind die Bremsmotoren BN_BA und Motoren mit beidseitig herausragender Welle (Option PS).

Ventilation

Les moteurs sont refroidis par ventilation externe (IC 411 selon CEI EN 60034-6) et sont équipés de ventilateur radial en plastique fonctionnant dans les deux sens de rotation.



L'installation doit garantir une distance minimum de la calotte cache-ventilateur par rapport au mur le plus proche de façon à ne pas créer d'empêchement à la circulation de l'air ainsi que pour permettre les interventions d'entretien ordinaire du moteur et, si présent, du frein.

Sur demande, à partir de la taille BN 71, ou M1, les moteurs peuvent être fournis avec ventilation forcée à alimentation indépendante. Le refroidissement est réalisé au moyen d'un ventilateur axial avec alimentation indépendante monté sur la calotte cache-ventilateur (méthode de refroidissement IC 416).

Cette exécution est utilisée en cas d'alimentation du moteur par variateur dans le but d'étendre aussi la plage de fonctionnement à couple constant aux faibles vitesses ou lorsque des fréquences de démarrage élevées sont nécessaire à celui-ci.

Les moteurs frein type BN_BA et les moteurs avec arbre sortant des deux côtés (option PS) SP sont exclus de cette option.

(A77)

Dati di alimentazione / Power supply / Daten der Stromversorgung / Données d'alimentation					
		V a.c. ± 10%	Hz	P [W]	I [A]
BN 71	M1	1~ 230	50 / 60	22	0.14
BN 80	M2			22	0.14
BN 90	—			40	0.25
BN 100 (*)	M3			50	0.25
BN 112	—	3~ 230 Δ / 400Y	50	50	0.26 / 0.15
BN 132S	M4S			110	0.38 / 0.22
BN 132M...BN 160MR	M4L				
BN 160...BN 180M	M5		50	180	1.25 / 0.72

Per la variante sono disponibili due esecuzioni alternative, denominate **U1** e **U2**, aventi lo stesso ingombro in senso longitudinale. Per entrambe le esecuzioni, la maggiore lunghezza della calotta copriventola (ΔL) è riportata nella tabella che segue. Dimensioni complessive ricavabili dalle tavole dimensionali dei motori.



This variant has two different models, called **U1** and **U2**, having the same longitudinal size. Longer side of fan cover (ΔL) is specified for both models in the table below. Overall dimension can be reckoned from motor size table.

Für die Varianten sind als Alternative zwei Ausführungen verfügbar: **U1** und **U2** mit dem gleichen Längsmaßen. Für beide Ausführungen wird die Verlängerung der Lüfterradkappe (ΔL) in der nachstehenden Tabelle wiedergegeben. Gesamtmaße können den Tabellen entnommen werden, in denen die Motormaße angegeben werden.

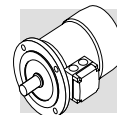
Pour la variante sont disponibles deux exécutions alternatives, dénommées **U1** et **U2**, ayant le même encombrement dans le sens longitudinal. Pour les deux exécutions, la majoration de la longueur de la calotte cache-ventilateur (ΔL) est indiquée dans le tableau suivant. Dimensions totales à calculer



(A78)

Tabella maggiorazione lunghezze motore / Extra length for servoveilated motors Tabelle - Motorverlängerung / Tableau majoration longueurs moteur			
		ΔL_1	ΔL_2
BN 71	M1	93	32
BN 80	M2	127	55
BN 90	—	131	48
BN 100	M3	119	28
BN 112	—	130	31
BN 132S	M4S	161	51
BN 132M	M4L	161	51

ΔL_1 = variazione dimensionale rispetto alla quota LB del motore standard corrispondente

ΔL_1 = extra length to LB value of corresponding standard motor

ΔL_1 = Maßänderung gegenüber Maß LB des entsprechenden Standardmotors

ΔL_1 = variation de dimension par rapport à la cote LB du moteur standard correspondant

ΔL_2 = variazione dimensionale rispetto alla quota LB del motore autofrenante corrispondente

ΔL_2 = extra length to LB value of corresponding brake motor

ΔL_2 = Maßänderung gegenüber Maß LB des entsprechenden Bremsmotors

ΔL_2 = variation de dimension par rapport à la cote LB du moteur frein correspondant

U1



Terminali di alimentazione del ventilatore in scatola morsetti separata.

Nei motori autofrenanti grandezza BN 71...BN 160MR, con variante **U1**, la leva di sblocco non è collocabile nella posizione AA.

Fan wiring terminals are housed in a separate terminal box.

*In brake motors of size BN 71...BN 160MR, with **U1** model, the release lever cannot be positioned to AA.*

Versorgungsanschlüsse des Ventilators im Zusatzklemmenkasten.

Bei den Bremsmotoren in der Baugröße BN 71...BN 160MR, mit Variante **U1** kann der Bremslösehebel nicht in der Position AA.

Bornes d'alimentation du ventilateur dans un bornier séparé.

Pour les moteurs frein taille BN 71...BN 160MR, avec variante **U1**, le levier de déblocage ne peut être installé en position AA.

U2



I terminali del ventilatore sono collocati nella scatola morsetti-
ra principale del motore.

L'opzione U2 non è applicabile ai motori da BN 160 a BN 200L, con eccezione dei motori BN 160MR, per i quali l'opzione è disponibile.

Fan terminals are wired in the motor terminal box.



The U2 option does not apply to motors BN 160 through BN 200L, with the only exception of motor BN 160MR for which the option is available instead.

Die Opzione ist für die Motoren BN160..BN200L nicht anwendbar, außer den Motoren BN160MR wofür die Option verfügbar ist.

Bornes d'alimentation du ventilateur dans le bornier principal du moteur.

L'option n'est pas applicable aux moteurs BN 160...BN 200L, sauf pour les moteurs BN 160MR, pour lesquels l'option est disponible

(A79)

(*)			V a.c. \pm 10%	Hz	P [W]	I [A]
	BN 100_U2	M3	3~ 230 Δ / 400Y	50 / 60	40	0.24 / 0.14

RC

Tettuccio parapigioggia

Il dispositivo parapigioggia, che è raccomandato quando il motore è montato verticalmente con l'albero verso il basso, serve a proteggere il motore stesso dall'ingresso di corpi solidi e dallo stillicidio.

Drip cover

The drip cover protects the motor from dripping and avoids the ingress of solid bodies. It is recommended when motor is installed in a vertical position with the shaft downwards.

Schutzdach

Das Schutzdach, dessen Montage dann empfohlen wird, wenn der Motor senkrecht mit einer nach unten gerichteten Welle ausgerichtet wird, dient dem Schutz des Motors vor einem Eindringen von festen Fremdkörpern und Tropfwasser.

Capot de protection anti-pluie

Le capot de protection anti-pluie est recommandé lorsque le moteur est monté verticalement avec l'arbre vers le bas, il sert à protéger le moteur contre l'introduction de corps solides et le suintement.

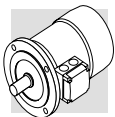



Le dimensioni aggiuntive sono indicate nella tabella (A80). Il tettuccio esclude le varianti PS, EN1, EN2, EN3 e non è applicabile ai motori con freno tipo BA

Relevant dimensions are indicated in the table (A80). The drip cover is not compatible with variants PS, EN1, EN2, EN3 and will not fit motors equipped with a BA brake.

Die Maßerweiterungen werden in der Tabelle (A80) angegeben. Das Schutzdach schließt die Möglichkeit der Varianten PS, EN1, EN2, EN3 und kann bei Motoren mit dem Bremstyp BA nicht montiert werden.

Les dimensions à ajouter sont indiquées dans le tableau (A80). Le capot antipluie exclue les variantes PS, EN1, EN2, EN3 et n'est pas applicable aux moteurs avec frein type BA

(A80)

		AQ	ΔV
BN 63	M05	118	24
BN 71	M1	134	27
BN 80	M2	134	25
BN 90	—	168	30
BN 100	M3	168	28
BN 112	—	211	32
BN 132...BN 160MR	M4	211	32
BN 160M...BN 180M	M5	270	36
BN 180L...BN 200L	—	310	36

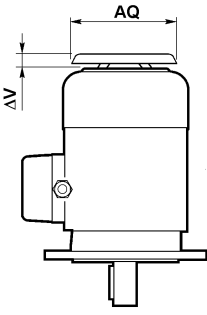

TC

Tettuccio tessile

La variante del tettuccio tipo TC è da specificare quando il motore è installato in ambienti dell'industria tessile, dove sono presenti filamenti che potrebbero ostruire la griglia del copriventola, impedendo il regolare flusso dell'aria di raffreddamento. L'opzione esclude le varianti EN1, EN2, EN3 e non è applicabile ai motori con freno tipo BA. L'ingombro complessivo è lo stesso del tettuccio tipo RC.

Textile canopy

Option TC is a cover variant for textile industry environments, where lint may obstruct the fan grid and prevent a regular flow of cooling air. This option is not compatible with variants EN1, EN2, EN3 and will not fit motors equipped with a BA brake. Overall dimensions are the same as drip cover type RC.

Schutzdach

Die Variante des Schutzdachs vom Typ TC muss dann spezifiziert werden, wenn der Motor in Bereichen der Textilindustrie installiert wird, in denen Stofffusseln das Lüfterradgitter verstopfen und so einen regulären Kühlluftfluss verhindern könnten. Diese Option schließt die Möglichkeit der Varianten EN1, EN2, EN3 aus und kann bei Motoren mit einer Bremse vom Typ BA nicht appliziert werden. Die Gesamtmaße entsprechen denen des Schutzdachs vom Typ RC.

Capot textile

La variante del capot type TC est à spécifier lorsque le moteur est installé dans des sites de l'industrie textile, où sont présents des filaments qui pourraient obstruer la grille du cache-ventilateur et empêcher le flux régulier de l'air de refroidissement. L'option exclue les variantes EN1, EN2, EN3 et n'est pas applicable aux moteurs avec frein type BA. L'encombrement total est identique à celui du capot type RC.

Dispositivi di retroazione

I motori possono essere dotati di tre diversi tipi di encoder, qui di seguito descritti. Il montaggio dell'encoder esclude le esecuzioni con doppia estremità d'albero (PS) e tettuccio di protezione (RC, TC). Il dispositivo non è applicabile ai motori dotati del freno in c.a., tipo BA.

Feedback units

Motors may be combined with three different types of encoders to achieve feedback circuits. Configurations with double-ended shaft (PS) and rain canopy (RC, TC) are not compatible with encoder installation. Also not compatible are motors equipped with a.c. brakes, type BA.

Geber-anschluß

Die Motoren können mit drei unterschiedlichen Encodertypen ausgestattet werden. Nachstehend finden Sie die entsprechenden Beschreibungen. Die Montage des Encoders schließt die Version mit zweitem Wellenende (PS) und Schutzdach (RC, TC) aus. Die Vorrichtung kann an Motoren mit Bremse vom Typ BA nicht angebaut werden.

Dispositifs de retroaction

Pour moteurs peuvent être dotés de trois types de codeurs différents, décrits ci-après. Le montage du codeur exclu les exécutions avec arbre à double extrémité (PS) et le capot de protection (RC, TC). Le dispositif n'est pas applicable aux moteurs avec frein en c.a., type BA.

EN1

Encoder incrementale, $V_{IN}=5V$, uscita line-driver RS 422.

Incremental encoder, $V_{IN}=5V$, line-driver output RS 422.

Inkremental-Encoder, $V_{IN}=5V$, Ausgang „line-driver“ RS 422.

Codeur incrémental, $V_{IN}=5V$, sortie line-driver RS 422.

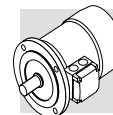

EN2

Encoder incrementale, $V_{IN}=10-30$ V, uscita line driver RS 422.

Incremental encoder, $V_{IN}=10-30$ V, line-driver output RS 422.

Inkremental-Encoder, $V_{IN}=10-30$ V, Ausgang „line driver“ RS 422.

Codeur incrémental, $V_{IN}=10-30$ V, sortie line-driver RS 422.

EN3

Encoder incrementale, $V_{IN}=12-30$ V, uscita push-pull 12-30 V



Incremental encoder, $V_{IN}=12-30$ V, push-pull output 12-30 V

Inkremental-Encoder, $V_{IN}=12-30$ V, Ausgang „push-pull“ 12-30 V



Codeur incrémental, $V_{IN}=12-30$ V, sortie push-pull 12-30 V

(A81)

	EN1	EN2	EN3
interfaccia / <i>Interface</i> Schnittstelle / <i>interface</i>	RS 422	RS 422	push-pull
tensione alimentazione / <i>Power supply voltage</i> Versorgungsspannung / <i>tension d'alimentation</i> [V]	4...6	10...30	12...30
tensione di uscita / <i>Output voltage</i> Ausgangsspannung / <i>tension de sortie</i> [V]	5	5	12...30
corrente di esercizio senza carico / <i>No-load operating current</i> Betriebsstrom ohne Belastung / <i>courant d'utilisation sans charge</i> [mA]	120	100	100
n° di impulsi per giro / <i>No. of pulses per revolution</i> Impulse pro Drehung / <i>nbre d'impulsions par tour</i>	1024		
n° segnali / <i>No. of signals</i> Signale / <i>nbre de signaux</i>	6 (A, B, C + segnali invertiti / <i>inverted signals</i> invertierte Signale / <i>signaux inversés</i>)		
max. frequenza di uscita / <i>Max. output frequency</i> Max. Ausgangsfrequenz / <i>fréquence max. de sortie</i> [kHz]	300	300	200
max. velocità / <i>Max. speed</i> Max. Drehzahl / <i>vitesse max.</i> [min ⁻¹]	600 (900 min ⁻¹) x 10s		
campo di temperatura / <i>Temperature range</i> Temperaturbereich / <i>plage de température</i> [°C]	-20...+70		
grado di protezione / <i>Protection class</i> Schutzgrad / <i>degré de protection</i>	IP 65		



Pn kW		n min ⁻¹	Mn Nm	η %	$\cos \varphi$	In A (400V)	$\frac{I_s}{I_n}$	$\frac{M_s}{M_n}$	$\frac{M_a}{M_n}$	Jm x 10 ⁻⁴ kgm ²	IM B5 	
0.06	BN 56A	4	1350	0.42	47	0.62	0.30	2.6	2.3	2.0	1.5	3.1
0.09	BN 56B	4	1350	0.64	52	0.62	0.40	2.6	2.5	2.4	1.5	3.1
0.12	BN 63A	4	1310	0.88	51	0.68	0.50	2.6	1.9	1.8	2.0	3.5
0.18	BN 63B	4	1320	1.30	53	0.68	0.72	2.6	2.2	2.0	2.3	3.9
0.25	BN 63C	4	1320	1.81	60	0.69	0.87	2.7	2.1	1.9	3.3	5.1
0.25	BN 71A	4	1375	1.74	62	0.77	0.76	3.3	1.9	1.7	5.8	5.1
0.37	BN 71B	4	1370	2.6	65	0.77	1.07	3.7	2.0	1.9	6.9	5.9
0.55	BN 71C	4	1380	3.8	69	0.74	1.55	4.1	2.3	2.3	9.1	7.3
0.55	BN 80A	4	1390	3.8	72	0.77	1.43	4.1	2.3	2.0	15	8.2
0.75	BN 80B	4	1400	5.1	75	0.78	1.85	4.9	2.7	2.5	20	9.9
1.1	BN 80C	4	1400	7.5	75	0.79	2.68	5.1	2.8	2.5	25	11.3
1.1	BN 90S	4	1400	7.5	73	0.77	2.82	4.6	2.6	2.2	21	12.2
1.5	BN 90LA	4	1410	10.2	77	0.77	3.7	5.3	2.8	2.4	28	13.6
1.85	BN 90LB	4	1400	12.6	77	0.78	4.4	5.2	2.8	2.6	30	15.1
2.2	BN 100LA	4	1410	14.9	78	0.76	5.4	4.5	2.2	2.0	40	18.3
3	BN 100LB	4	1410	20	80	0.78	6.9	5	2.3	2.2	54	22
4	BN 112M	4	1420	27	83	0.78	8.9	5.6	2.7	2.5	98	30
5.5	BN 132S	4	1440	36	84	0.80	11.8	5.5	2.3	2.2	213	44
7.5	BN 132MA	4	1440	50	85	0.81	15.7	5.7	2.5	2.4	270	53
9.2	BN 132MB	4	1440	61	86	0.81	19.1	5.9	2.7	2.5	319	59
11	BN 160MR	4	1440	73	87	0.82	22.3	5.9	2.7	2.5	360	70
15	BN 160L	4	1460	98	89	0.82	29.7	5.9	2.3	2.1	650	99
18.5	BN 180M	4	1460	121	89	0.81	37.0	6.2	2.6	2.5	790	115
22	BN 180L	4	1465	143	89	0.82	45	6.5	2.5	2.5	1250	135
30	BN 200L	4	1465	196	90	0.83	58	7.1	2.7	2.8	1650	157

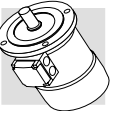

freno c.c. / d.c. brake G.S.-bremse / frein c.c.					
FD					
Mod	Mb Nm	Z _o 1/h NB SB	Jm x 10 ⁻⁴ Kgm ²	IM B5 	
FD 02	1.75	10000	13000	2.6	5.2
FD 02	3.5	10000	13000	3.0	5.6
FD 02	3.5	7800	10000	3.9	6.8
FD 03	3.5	7700	11000	6.9	7.8
FD 03	5.0	6000	9400	8.0	8.6
FD 53	7.5	4300	8700	10.2	10
FD 04	10	4100	8000	16.6	12.1
FD 04	15	4100	7800	22	13.8
FD 04	15	2600	5300	27	15.2
FD 14	15	4800	8000	23	16.4
FD 05	26	3400	6000	32	19.6
FD 05	26	3200	5900	34	21.1
FD 15	40	2600	4700	44	25
FD 15	40	2400	4400	58	28
FD 06S	60	—	1400	107	40
FD 56	75	—	1050	223	57
FD 06	100	—	950	280	66
FD 07	150	—	900	342	75
FD 07	150	—	850	382	86
FD 08	200	—	750	725	129
FD 08	250	—	700	865	145
FD 09	300	—	400	1450	175
FD 09	400	—	300	1850	197

freno c.a. / a.c. brake W.S.-bremse / frein c.a.									
FA					BA				
Mod.	Mb Nm	Z _o 1/h	Jm x 10 ⁻⁴ kgm ²	IM B5 	Mod.	Mb max Nm	Z _o 1/h	Jm x 10 ⁻⁴ kgm ²	IM B5 
FA 02	1.75	13000	2.6	5.0	BA 60	5	9000	4.0	5.8
FA 02	3.5	13000	3.0	5.4	BA 60	5	9000	4.3	6.2
FA 02	3.5	10000	3.9	6.6	BA 60	5	8500	5.3	7.4
FA 03	3.5	11000	6.9	7.5	BA 70	8	9700	7.8	9.0
FA 03	5.0	9400	8.0	8.3	BA 70	8	8500	8.9	9.8
FA 03	7.5	8700	10.2	9.7	BA 70	8	8000	11.1	11.2
FA 04	10	8000	16.6	12.0	BA 80	18	7400	18	13.5
FA 04	15	7800	22	13.7	BA 80	18	7400	23	15.2
FA 04	15	5300	27	15.1	BA 80	18	5100	28	16.6
FA 14	15	8000	23	16.3	BA 90	35	6500	28	19.5
FA 05	26	6000	32	20.3	BA 90	35	5400	35	21
FA 05	26	5900	34	21.8	BA 90	35	5400	37	22.5
FA 15	40	4700	44	25	BA 100	50	4000	52	29
FA 15	40	4400	58	29	BA 100	50	3800	66	32
FA 06S	60	2100	107	42	BA 110	75	2000	114	43
FA 06	75	1200	223	58	BA 140	150	1200	263	76
FA 07	100	1000	280	71	BA 140	150	1000	320	85
FA 07	150	900	342	77	BA 140	150	900	369	91
FA 07	150	850	382	88					
FA 08	200	750	710	128					
FA 08	250	700	850	144					



6 P**1000 min⁻¹ - S1****50 Hz**

Pn kW		n min ⁻¹	Mn Nm	η %	cos φ	In A (400V)	I_s In	M_s Mn	M_a Mn	$J_m \times 10^{-4}$ kgm ²	IM B5 	
0.09	BN 63A	6	880	0.98	41	0.53	0.60	2.1	1.8	3.4	4.6	
0.12	BN 63B	6	870	1.32	45	0.60	0.64	2.1	1.7	3.7	4.9	
0.18	BN 71A	6	900	1.91	56	0.69	0.67	2.6	1.9	1.7	8.4	5.5
0.25	BN 71B	6	900	2.7	62	0.71	0.82	2.6	1.9	1.7	10.9	6.7
0.37	BN 71C	6	910	3.9	66	0.69	1.17	3	2.4	2.0	12.9	7.7
0.37	BN 80A	6	910	3.9	68	0.68	1.15	3.2	2.2	2.0	21	9.9
0.55	BN 80B	6	920	5.7	70	0.69	1.64	3.9	2.6	2.2	25	11.3
0.75	BN 80C	6	920	7.8	70	0.65	2.38	3.8	2.5	2.2	28	12.2
0.75	BN 90S	6	920	7.8	69	0.68	2.31	3.8	2.4	2.2	26	12.6
1.1	BN 90L	6	920	11.4	72	0.69	3.2	3.9	2.3	2.0	33	15
1.5	BN 100LA	6	940	15.2	73	0.72	4.1	4	2.1	2.0	82	22
1.85	BN 100LB	6	930	19.0	75	0.73	4.9	4.5	2.1	2.0	95	24
2.2	BN 112M	6	940	22	78	0.73	5.6	4.8	2.2	2.0	168	32
3	BN 132S	6	940	30	76	0.76	7.5	4.8	1.9	1.8	216	36
4	BN 132MA	6	950	40	78	0.77	9.6	5.5	2.0	1.8	295	45
5.5	BN 132MB	6	945	56	80	0.78	12.7	5.9	2.1	1.9	383	56
7.5	BN 160M	6	955	75	84	0.81	15.9	5.9	2.2	2.0	740	83
11	BN 160L	6	960	109	87	0.81	22.5	6.5	2.5	2.3	970	103
15	BN 180L	6	970	148	88	0.82	30	6.2	2.0	2.4	1550	130
18.5	BN 200LA	6	960	184	88	0.81	37	5.9	2.0	2.3	1700	145

freno c.c. / d.c. brake G.S.-bremse / frein c.c.						freno c.a. / a.c. brake W.S.-bremse / frein c.a.									
FD						FA				BA					
Mod.	Mb Nm	Z _o 1/h NB SB		Jm x 10 ⁻⁴ kgm ²	IM B5 	Mod.	Mb Nm	Z _o 1/h	Jm x 10 ⁻⁴ kgm ²	IM B5 	Mod.	Mb max Nm	Z _o 1/h	Jm x 10 ⁻⁴ kgm ²	IM B5 
FD 02	3.5	9000	14000	4.0	6.3	FA 02	3.5	14000	4.0	6.1	BA 60	5	12000	5.4	6.9
FD 02	3.5	9000	14000	4.3	6.6	FA 02	3.5	14000	4.3	6.4	BA 60	5	12000	5.7	7.2
FD 03	5.0	8100	13500	9.5	8.2	FA 03	5.0	13500	9.5	7.9	BA 70	8	12300	10.4	9.4
FD 03	5.0	7800	13000	12	9.4	FA 03	5.0	13000	12	9.1	BA 70	8	12000	12.9	10.6
FD 53	7.5	5100	9500	14	10.4	FA 03	7.5	9500	14	10.1	BA 70	8	8900	14.9	11.6
FD 04	10	5200	8500	23	13.8	FA 04	10	8500	23	13.7	BA 80	18	8000	24	15.2
FD 04	15	4800	7200	27	15.2	FA 04	15	7200	27	15.1	BA 80	18	6800	28	16.6
FD 04	15	3400	6400	30	16.1	FA 04	15	6400	30	16.0	BA 80	18	6100	31	17.5
FD 14	15	3400	6500	28	16.8	FA 14	15	6500	28	16.7	BA 90	35	5500	33	19.9
FD 05	26	2700	5000	37	21	FA 05	26	5000	37	22	BA 90	35	4600	40	22
FD 15	40	1900	4100	86	28	FA 15	40	4100	86	29	BA 100	50	3800	94	32
FD 15	40	1700	3600	99	30	FA 15	40	3600	99	31	BA 100	50	3400	107	34
FD 06S	60	—	2100	177	42	FA 06S	60	2100	177	44	BA 110	75	2000	184	45
FD 56	75	—	1400	226	49	FA 06	75	1400	226	50	BA 140	150	1200	266	68
FD 06	100	—	1200	305	58	FA 07	100	1200	318	63	BA 140	150	1050	345	77
FD 07	150	—	1050	406	72	FA 07	150	1050	406	74	BA 140	150	1000	433	88
FD 08	170	—	900	815	112	FA 08	170	900	815	113					
FD 08	200	—	800	1045	133	FA 08	200	800	1045	133					
FD 09	300	—	600	1750	170										
FD 09	400	—	450	1900	185										



Pn kW		n min ⁻¹	Mn Nm	η %	$\cos \varphi$	In A (400V)	$\frac{I_s}{I_n}$	$\frac{M_s}{M_n}$	$\frac{M_a}{M_n}$	Jm x 10 ⁻⁴ kgm ²	IM B5 	
0.20	BN 63B	2	2700	0.71	55	0.82	0.64	3.5	2.1	1.9	2.9	4.4
0.15		4	1350	1.06	49	0.67	0.66	2.6	1.8	1.7		
0.28	BN 71A	2	2700	0.99	56	0.82	0.88	2.9	1.9	1.7	4.7	4.4
0.20		4	1370	1.39	59	0.72	0.68	3.1	1.8	1.7		
0.37	BN 71B	2	2740	1.29	56	0.82	1.16	3.5	1.8	1.8	5.8	5.1
0.25		4	1390	1.72	60	0.73	0.82	3.3	2.0	1.9		
0.45	BN 71C	2	2780	1.55	63	0.85	1.21	3.8	1.8	1.8	6.9	5.9
0.30		4	1400	2.0	63	0.73	0.94	3.6	2.0	1.9		
0.55	BN 80A	2	2800	1.9	63	0.85	1.48	3.9	1.7	1.7	15	8.2
0.37		4	1400	2.5	67	0.79	1.01	4.1	1.8	1.9		
0.75	BN 80B	2	2780	2.6	65	0.85	1.96	3.8	1.9	1.8	20	9.9
0.55		4	1400	3.8	68	0.81	1.44	3.9	1.7	1.7		
1.1	BN 90S	2	2790	3.8	71	0.82	2.73	4.7	2.3	2.0	21	12.2
0.75		4	1390	5.2	66	0.79	2.08	4.6	2.4	2.2		
1.5	BN 90L	2	2780	5.2	70	0.85	3.64	4.5	2.4	2.1	28	14.0
1.1		4	1390	7.6	73	0.81	2.69	4.7	2.5	2.2		
2.2	BN 100LA	2	2800	7.5	72	0.85	5.2	4.5	2.0	1.9	40	18.3
1.5		4	1410	10.2	73	0.79	3.8	4.7	2.0	2.0		
3.5	BN 100LB	2	2850	11.7	80	0.84	7.5	5.4	2.2	2.1	61	25
2.5		4	1420	16.8	82	0.80	5.5	5.2	2.2	2.2		
4	BN 112M	2	2880	13.3	79	0.83	8.8	6.1	2.4	2.0	98	30
3.3		4	1420	22.2	80	0.80	7.4	5.1	2.1	2.0		
5.5	BN 132S	2	2890	18.2	80	0.87	11.4	5.9	2.4	2.0	213	44
4.4		4	1440	29	82	0.84	9.2	5.3	2.2	2.0		
7.5	BN 132MA	2	2900	25	82	0.87	15.2	6.5	2.4	2.0	270	53
6		4	1430	40	84	0.85	12.1	5.8	2.3	2.1		
9.2	BN 132MB	2	2920	30	83	0.86	18.6	6.0	2.6	2.2	319	59
7.3		4	1440	48	85	0.85	14.6	5.5	2.3	2.1		

freno c.c. / d.c. brake G.S.-bremse / frein c.c.					
FD					
Mod.	Mb Nm	Z _o 1/h NB SB	Jm x 10 ⁻⁴ kgm ²	IM B5 	
FD 02	3.5	2200 2600 4000 5100	3.5	6.1	
FD 03	3.5	2100 2400 3800 4800	5.8	7.1	
FD 03	5	1400 2100 2900 4200	6.9	7.8	
FD 03	5	1400 2100 2900 4200	8.0	8.6	
FD 04	5	1600 2300 3000 4000	16.6	12.1	
FD 04	10	1400 1600 2700 3600	22	13.8	
FD 14	10	1500 1600 2300 2800	23	16.4	
FD 05	26	1050 1200 1600 2000	32	20	
FD 15	26	600 900 1300 2300	44	25	
FD 15	40	500 900 1000 2100	65	31	
FD 06S	60	— 700 — 1200	107	40	
FD 56	75	— 350 — 900	223	57	
FD 06	100	— 350 — 900	280	66	
FD 07	150	— 300 — 800	342	75	

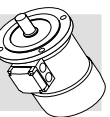

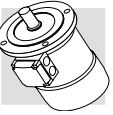
freno c.a. / a.c. brake W.S.-bremse / frein c.a.									
FA					BA				
Mod.	Mb Nm	Z _o 1/h	Jm x 10 ⁻⁴ kgm ²	IM B5 	Mod.	Mb max Nm	Z _o 1/h	Jm x 10 ⁻⁴ kgm ²	IM B5
FA 02	3.5	2600 5100	3.5	5.9	BA 60	5	2000 4000	4.9	6.7
FA 03	3.5	2400 4800	5.8	6.8	BA 70	8	2100 4200	5.6	8.3
FA 03	5	2100 4200	6.9	7.5	BA 70	8	1800 3600	7.8	9.0
FA 03	5	2100 4200	8.0	8.3	BA 70	8	1800 3600	8.9	9.8
FA 04	5	2300 4000	16.6	12.0	BA 80	18	2100 3700	18	13.5
FA 04	10	1600 3600	22	13.7	BA 80	18	1500 3300	22	15.2
FA 14	10	1600 2800	23	16.3	BA 90	35	1300 2300	28	19.5
FA 05	26	1200 2000	32	21	BA 90	35	1100 1800	35	21
FA 15	26	900 2300	44	25	BA 100	50	750 1900	51	29
FA 15	40	900 2100	65	32	BA 100	50	750 1800	72	35
FA 06S	60	700 1200	107	42	BA 110	75	600 1100	114	43
FA 06	75	350 900	223	58	BA 140	150	300 750	263	76
FA 07	100	350 900	293	71	BA 140	150	300 800	320	85
FA 07	150	300 800	342	77	BA 140	150	300 750	369	91





2/6 P**3000/1000 min⁻¹ - S3 60/40%****50 Hz**



Pn kW		n min ⁻¹	Mn Nm	η %	$\cos \varphi$	In A (400V)	$\frac{I_s}{I_n}$	$\frac{M_s}{M_n}$	$\frac{M_a}{M_n}$	Jm $\times 10^{-4}$ kgm ²	IM B5 	
0.25 0.08	BN 71A	2 6	2850 910	0.84 0.84	60 43	0.82 0.70	0.73 0.38	4.3 2.1	1.9 1.4	1.8 1.5	6.9 5.9	5.9
0.37 0.12	BN 71B	2 6	2880 900	1.23 1.27	62 44	0.80 0.73	1.08 0.54	4.4 2.4	1.9 1.4	1.8 1.5	9.1 7.3	7.3
0.55 0.18	BN 80A	2 6	2800 930	1.88 1.85	63 52	0.86 0.65	1.47 0.77	4.5 3.3	1.9 2	1.7 1.9	20 9.9	9.9
0.75 0.25	BN 80B	2 6	2800 930	2.6 2.6	66 54	0.87 0.67	1.89 1.00	4.3 3.2	1.8 1.7	1.6 1.8	25 11.3	11.3
1.1 0.37	BN 90L	2 6	2860 920	3.7 3.8	67 59	0.84 0.71	2.82 1.27	4.7 3.3	2.1 1.6	1.9 1.6	28 14.0	14.0
1.5 0.55	BN 100LA	2 6	2880 940	5.0 5.6	73 64	0.84 0.67	3.53 1.85	5.1 3.5	1.9 1.7	2.0 1.8	40 18.3	18.3
2.2 0.75	BN 100LB	2 6	2900 950	7.2 7.5	77 67	0.85 0.64	4.9 2.5	5.9 3.3	2.0 1.9	2.0 1.8	61 25	25
3 1.1	BN 112M	2 6	2900 950	9.9 11.1	78 72	0.87 0.64	6.4 3.4	6.3 3.9	2.0 1.8	2.1 1.8	98 30	30
4.5 1.5	BN 132S	2 6	2910 960	14.8 14.9	78 74	0.84 0.67	9.9 4.4	5.8 4.2	1.9 1.9	1.8 2.0	213 44	44
5.5 2.2	BN 132M	2 6	2920 960	18.0 22	78 77	0.87 0.71	11.7 5.8	6.2 4.3	2.1 2.1	1.9 2.0	270 53	53

freno c.c. / d.c. brake G.S.-bremse / frein c.c.					
FD					
Mod.	Mb Nm	Z _o 1/h NB SB	Jm $\times 10^{-4}$ kgm ²	IM B5 	
FD 03	1.75	1500 10000	1700 13000	8.0	8.6
FD 03	3.5	1000 9000	1300 11000	10.2	10.0
FD 04	5	1500 4100	1800 6300	22	13.8
FD 04	5	1700 3800	1900 6000	27	15.2
FD 05	13	1400 3400	1600 5200	32	20
FD 15	13	1000 2900	1200 4000	44	24
FD 15	26	700 2100	900 3000	65	31
FD 06S	40	— —	1000 2600	107	40
FD 56	37	— —	500 2100	223	57
FD 56	50	— —	400 1900	280	66

freno c.a. / a.c. brake W.S.-bremse / frein c.a.									
FA					BA				
Mod.	Mb Nm	Z _o 1/h	Jm $\times 10^{-4}$ kgm ²	IM B5 	Mod.	Mb max Nm	Z _o 1/h	Jm $\times 10^{-4}$ kgm ²	IM B5 
FA 03	2.5	1700 13000	8.0	8.3	BA 70	8	1500 11000	8.9	9.8
FA 03	3.5	1300 11000	10.2	9.7	BA 70	8	1200 10000	11.1	11.2
FA 04	5	1800 6300	22	13.7	BA 80	18	1700 6000	23	15.2
FA 04	5	1900 6000	27	15.1	BA 80	18	1800 5600	28	16.6
FA 05	13	1600 5200	32	21	BA 90	35	1500 4700	35	21
FA 15	13	1200 4000	44	25	BA 100	50	1050 3500	51	29
FA 15	26	900 3000	65	32	BA 100	50	800 2700	72	36
FA 06S	40	1000 2600	107	32	BA 110	75	930 2400	114	43
FA 06	37	500 2100	223	58	BA 140	150	400 1700	263	76
FA 06	50	400 1900	280	67	BA 140	150	350 1600	320	85



Pn kW		n min ⁻¹	Mn Nm	η %	$\cos \varphi$	In A (400V)	$\frac{I_s}{I_n}$	$\frac{M_s}{M_n}$	$\frac{M_a}{M_n}$	Jm x 10 ⁻⁴ kgm ²	IM B5 
0.25 0.06	BN 71A	2 8	2790 680	0.86 0.84	61 31	0.87 0.61	0.68 0.46	3.9 2	1.8 1.8	1.9 1.9	10.9 6.7
0.37 0.09	BN 71B	2 8	2800 670	1.26 1.28	63 34	0.86 0.75	0.99 0.51	3.9 1.8	1.8 1.4	1.9 1.5	12.9 7.7
0.55 0.13	BN 80A	2 8	2830 690	1.86 1.80	66 41	0.86 0.64	1.40 0.72	4.4 2.3	2.1 1.6	2.0 1.7	20 9.9
0.75 0.18	BN 80B	2 8	2800 690	2.6 2.5	68 43	0.88 0.66	1.81 0.92	4.6 2.3	2.1 1.6	2.0 1.7	25 11.3
1.1 0.28	BN 90L	2 8	2830 690	3.7 3.9	63 48	0.84 0.63	3.00 1.34	4.5 2.4	2.1 1.8	1.9 1.9	28 14
1.5 0.37	BN 100LA	2 8	2880 690	5.0 5.1	69 46	0.85 0.63	3.69 1.84	4.7 2.1	1.9 1.6	1.8 1.6	40 18.3
2.4 0.55	BN 100LB	2 8	2900 700	7.9 7.5	75 54	0.82 0.58	5.6 2.5	5.4 2.6	2.1 1.8	2.0 1.8	61 25
3 0.75	BN 112M	2 8	2900 690	9.9 10.4	76 60	0.87 0.65	6.5 2.8	6.3 2.5	2.1 1.6	1.9 1.6	98 30
4 1	BN 132S	2 8	2870 690	13.3 13.8	73 66	0.84 0.62	9.4 3.5	5.6 2.9	2.3 1.9	2.4 1.8	213 44
5.5 1.5	BN 132M	2 8	2870 690	18.3 21	75 68	0.84 0.63	12.6 5.1	6.1 2.9	2.4 1.9	2.5 1.9	270 53

freno c.c. / d.c. brake G.S.-bremse / frein c.c.					
FD					
Mod.	Mb Nm	Z _o 1/h NB SB	Jm x 10 ⁻⁴ kgm ²	IM B5 	
FD 03	1.75	1300 10000	1400 13000	12	9.4
FD 03	3.5	1200 9500	1300 13000	14	10.4
FD 04	5	1500 5600	1800 8000	22	13.8
FD 04	10	1700 4800	1900 7300	27	15.2
FD 05	13	1400 3400	1600 5100	32	20
FD 15	13	1000 3300	1200 5000	44	25
FD 15	26	550 2000	700 3500	65	31
FD 06S	40	— —	900 2900	107	40
FD 56	37	— —	500 3500	223	57
FD 06	50	— —	400 2400	280	66

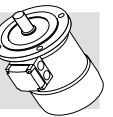

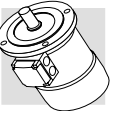
freno c.a. / a.c. brake W.S.-bremse / frein c.a.									
FA					BA				
Mod.	Mb Nm	Z _o 1/h	Jm x 10 ⁻⁴ kgm ²	IM B5 	Mod.	Mb max Nm	Z _o 1/h	Jm x 10 ⁻⁴ kgm ²	IM B5 
FA 03	2.5	1400 13000	12	9.1	BA 70	8	1300 12000	12.9	10.6
FA 03	3.5	1300 13000	14	10.1	BA 70	8	1200 12000	14.9	11.6
FA 04	5	1800 8000	22	13.7	BA 80	18	1700 7500	23	15.2
FA 04	10	1900 7300	27	15.1	BA 80	18	1800 7000	28	16.6
FA 05	13	1600 5100	32	21	BA 90	35	1400 4500	35	21
FA 15	13	1200 5000	44	25	BA 100	50	1000 4200	52	29
FA 15	26	700 3500	65	32	BA 100	50	600 3100	72	36
FA 06S	40	900 2900	107	42	BA 110	75	800 2700	114	43
FA 06	37	500 3500	223	58	BA 140	150	400 3000	263	76
FA 06	50	400 2400	280	67	BA 140	150	350 2100	320	85





2/12 P**3000/500 min⁻¹ - S3 60/40%****50 Hz**



P _n kW		n min ⁻¹	M _n Nm	η %	cos φ	I _n A (400V)	I _s / I _n	M _s / M _n	M _a / M _n	J _m x 10 ⁻⁴ kgm ²	IM B5 
0.55 0.09	BN 80B	2 12	2820 430	1.86 2.0	64 30	0.89 0.63	1.39 0.69	4.2 1.8	1.6 1.9	1.7 1.8	25 11.3
0.75 0.12	BN 90L	2 12	2790 430	2.6 2.7	56 26	0.89 0.63	2.17 1.06	4.2 1.7	1.8 1.4	1.7 1.6	26 12.6
1.1 0.18	BN 100LA	2 12	2850 430	3.7 4.0	65 26	0.85 0.54	2.87 1.85	4.5 1.5	1.6 1.3	1.8 1.5	40 18.3
1.5 0.25	BN 100LB	2 12	2900 440	4.9 5.4	67 36	0.86 0.46	3.76 2.18	5.6 1.8	1.9 1.7	1.9 1.8	54 22
2 0.3	BN 112M	2 12	2900 460	6.6 6.2	74 46	0.88 0.43	4.43 2.19	6.5 2	2.1 2	2 2	98 30
3 0.5	BN 132S	2 12	2920 470	9.8 10.2	74 51	0.87 0.43	6.7 3.3	6.8 2	2.3 1.7	1.9 1.6	213 44
4 0.7	BN 132M	2 12	2920 460	13.1 14.5	75 53	0.89 0.44	8.6 4.3	5.9 1.9	2.4 1.7	2.3 1.6	270 53

freno c.c. / d.c. brake G.S.-bremse / frein c.c.					
FD					
Mod.	M _b Nm	Z _o 1/h NB SB		J _m x 10 ⁻⁴ kgm ²	IM B5 
FD 04	5	1000 8000	1300 12000	27	15.2
FD 05	13	1000 4600	1150 6300	30	18.6
FD 15	13	700 4000	900 6000	44	25
FD 15	13	700 3800	900 5000	58	28
FD 06S	20	— —	800 3400	107	40
FD 56	37	— —	450 3000	223	57
FD 56	37	— —	400 2800	280	66

freno c.a. / a.c. brake W.S.-bremse / frein c.a.									
FA					BA				
Mod.	M _b Nm	Z _o 1/h	J _m x 10 ⁻⁴ kgm ²	IM B5 	Mod.	M _b max Nm	Z _o 1/h	J _m x 10 ⁻⁴ kgm ²	IM B5 
FA 04	5	1300 12000	27	15.1	BA 80	18	1200 11000	28	16.6
FA 05	13	1150 6300	30	19.3	BA 90	35	1050 5700	33	19.9
FA 15	13	900 6000	44	25	BA 100	50	750 5000	52	29
FA 15	13	900 5000	58	29	BA 100	50	800 4300	66	32
FA 06S	20	800 3400	107	42	BA 110	75	750 3200	114	43
FA 06	37	450 3000	223	58	BA 140	150	380 2500	263	76
FA 06	37	400 2800	280	67	BA 140	150	350 2500	320	85



P _n kW		n min ⁻¹	M _n Nm	η %	cos φ	I _n A (400V)	l _s in	M _s Mn	M _a Mn	J _m x 10 ⁻⁴ kgm ²	IM B5 
0.22 0.13	BN 71B	4 6	1410 920	1.5 1.4	64 43	0.74 0.67	0.67 0.65	3.9 2.3	1.8 1.6	1.9 1.7	9.1 7.3
0.30 0.20	BN 80A	4 6	1410 930	2.0 2.1	61 54	0.82 0.66	0.87 0.81	3.5 3.2	1.3 1.9	1.5 2.0	15 8.2
0.40 0.26	BN 80B	4 6	1430 930	2.7 2.7	63 55	0.75 0.70	1.22 0.97	3.9 2.7	1.8 1.5	1.8 1.6	20 9.9
0.55 0.33	BN 90S	4 6	1420 930	3.7 3.4	70 62	0.78 0.70	1.45 1.10	4.5 3.7	2.0 2.3	1.9 2.0	21 12.2
0.75 0.45	BN 90L	4 6	1420 920	5.0 4.7	74 66	0.78 0.71	1.88 1.39	4.3 3.3	1.9 2.0	1.8 1.9	28 14
1.1 0.8	BN 100LA	4 6	1450 950	7.2 8.0	74 65	0.79 0.69	2.72 2.57	5.0 4.1	1.7 1.9	1.9 2.1	82 22
1.5 1.1	BN 100LB	4 6	1450 950	9.9 11.1	75 72	0.79 0.68	3.65 3.24	5.1 4.3	1.7 2.0	1.9 2.1	95 25
2.3 1.5	BN 112M	4 6	1450 960	15.2 14.9	75 73	0.78 0.72	5.7 4.1	5.2 4.9	1.8 2.0	1.9 2.0	168 32
3.1 2	BN 132S	4 6	1460 960	20 20	83 77	0.83 0.75	6.5 4.9	5.9 4.5	2.1 2.1	2.0 2.1	213 44
4.2 2.6	BN 132MA	4 6	1460 960	27 26	84 79	0.82 0.72	8.8 6.6	5.9 4.3	2.1 2.0	2.2 2.0	270 53

freno c.c. / d.c. brake G.S.-bremse / frein c.c.					
FD					
Mod.	M _b Nm	Z _o 1/h NB SB	J _m x 10 ⁻⁴ kgm ²	IM B5 	
FD 03	3.5	2500 5000	3500 9000	10.2	10
FD 04	5	2500 4000	3100 6000	16.6	12.1
FD 04	10	1800 3600	2300 5500	22	13.8
FD 14	10	1500 2500	2100 4100	23	16.1
FD 05	13	1400 2300	2000 3600	32	20
FD 15	26	1400 2100	2000 3300	86	28
FD 15	26	1300 2000	1800 3000	99	31
FD 06S	40	— —	1600 2400	177	42
FD 56	37	— —	1200 1900	223	57
FD 06	50	— —	900 1500	280	66

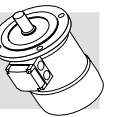

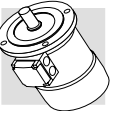
freno c.a. / a.c. brake W.S.-bremse / frein c.a.									
FA					BA				
Mod.	M _b Nm	Z _o 1/h	J _m x 10 ⁻⁴ kgm ²	IM B5 	Mod.	M _b max Nm	Z _o 1/h	J _m x 10 ⁻⁴ kgm ²	IM B5 
FA 03	3.5	3500 9000	10.2	9.7	BA 70	8	3200 8200	11.1	11.2
FA 04	5	3100 6000	16.6	12.0	BA 80	18	2800 5500	18	13.5
FA 04	10	2300 5500	22	13.7	BA 80	18	2200 5200	23	15.2
FA 14	10	2100 4100	23	16.3	BA 90	35	1700 3300	28	19.5
FA 05	13	2000 3600	32	21	BA 90	35	1800 3300	35	21
FA 15	26	2000 3300	86	29	BA 100	50	1800 3000	94	32
FA 15	26	1800 3000	99	32	BA 100	50	1600 2800	107	34
FA 06S	40	1600 2400	177	44	BA 110	75	1500 2300	184	45
FA 06	37	1200 1900	223	58	BA 140	150	1000 1600	263	76
FA 06	50	900 1500	280	67	BA 140	150	800 1300	320	85





4/8 P**1500/750 min⁻¹ - S1****50 Hz**

Pn kW		n min ⁻¹	Mn Nm	η %	$\cos \varphi$	In A (400V)	I_s In	$\frac{M_s}{M_n}$	$\frac{M_a}{M_n}$	$J_m \times 10^{-4}$ kgm ²	IM B5 	
0.37 0.18	BN 80A	4 8	1400 690	2.5 2.5	63 44	0.82 0.60	1.03 0.98	3.3 2.2	1.4 1.5	1.4 1.6	15	8.2
0.55 0.30	BN 80B	4 8	1390 670	3.8 4.3	65 49	0.86 0.65	1.42 1.36	3.8 2.3	1.7 1.7	1.6 1.8	20	9.9
0.65 0.35	BN 90S	4 8	1390 690	4.5 4.8	73 49	0.85 0.57	1.51 1.81	4.0 2.5	1.9 2.1	1.9 2.2	28	13.6
0.9 0.5	BN 90L	4 8	1370 670	6.3 7.1	73 57	0.87 0.62	2.05 2.04	3.8 2.4	1.8 2.1	1.8 2	30	15.1
1.3 0.7	BN 100LA	4 8	1420 700	8.7 9.6	72 58	0.83 0.64	3.14 2.72	4.3 2.8	1.7 1.8	1.8 1.8	82	22
1.8 0.9	BN 100LB	4 8	1420 700	12.1 12.3	69 62	0.87 0.63	4.3 3.3	4.2 3.2	1.6 1.7	1.7 1.8	95	25
2.2 1.2	BN 112M	4 8	1440 710	14.6 16.1	77 70	0.85 0.63	4.9 3.9	5.3 3.3	1.8 1.9	1.8 1.8	168	32
3.6 1.8	BN 132S	4 8	1440 720	24 24	80 72	0.82 0.55	7.9 6.6	6.5 4.6	2.1 1.9	1.9 2	295	45
4.6 2.3	BN 132M	4 8	1450 720	30 31	81 73	0.83 0.54	9.9 8.4	6.5 4.4	2.2 2.3	1.9 2	383	56

freno c.c. / d.c. brake G.S.-bremse / frein c.c.					
FD					
Mod.	Mb Nm	Z _o 1/h	J _m x 10 ⁻⁴ kgm ²	IM B5 	
FD 04	10	2300 4500	3500 7000	16.6	12.1
FD 04	10	2200 4200	2900 6500	22	13.8
FD 14	15	2300 3500	2800 6000	30	17.8
FD 05	26	1700 2500	2100 4200	34	21
FD 15	40	1300 2000	1700 3400	86	28
FD 15	40	1200 1600	1700 2600	99	31
FD 06S	60	— —	1200 2000	177	42
FD 56	75	— —	1000 1400	305	58
FD 06	100	— —	1000 1300	393	69

freno c.a. / a.c. brake W.S.-bremse / frein c.a.									
FA					BA				
Mod.	Mb Nm	Z _o 1/h	J _m x 10 ⁻⁴ kgm ²	IM B5 	Mod.	Mb max Nm	Z _o 1/h	J _m x 10 ⁻⁴ kgm ²	IM B5 
FA 04	10	3500 7000	16.6	12.0	BA 80	18	3200 6500	18	13.5
FA 04	10	2900 6500	22	13.7	BA 80	18	2500 5600	23	15.2
FA 14	15	2800 6000	30	17.7	BA 90	35	2400 5100	35	21
FA 05	26	2100 4200	34	22	BA 90	35	1900 3800	37	22
FA 15	40	1700 3400	86	29	BA 100	50	1500 3100	94	32
FA 15	40	1700 2600	99	32	BA 100	50	1500 2400	107	34
FA 06S	60	1200 2000	177	43	BA 110	75	1100 1900	184	45
FA 06	75	1000 1400	305	59	BA 140	150	900 1200	345	77
FA 07	100	1000 1300	406	74	BA 140	150	900 1200	433	88



Pn kW		n min ⁻¹	Mn Nm	η %	cos φ	In A (400V)	$\frac{I_s}{I_n}$	$\frac{M_s}{M_n}$	$\frac{M_a}{M_n}$	Jm $\times 10^{-4}$ kgm ²	IM B9 
0.18	M 05A	2	2700	0.64	53	0.78	0.63	3.0	2.1	2.0	3.2
0.25	M 05B	2	2700	0.88	62	0.78	0.75	3.3	2.3	2.3	3.6
0.37	M 05C	2	2750	1.29	64	0.79	1.06	3.9	2.6	3.3	4.8
0.55	M 1SD	2	2810	1.87	73	0.77	1.41	5	2.9	2.8	5.8
0.75	M 1LA	2	2800	2.6	74	0.77	1.90	5.1	3.1	2.8	6.9
1.1	M 2SA	2	2800	3.8	76	0.77	2.71	4.8	2.8	2.4	9.0
1.5	M 2SB	2	2800	5.1	80	0.81	3.3	4.9	2.7	2.4	11.4
2.2	M 3SA	2	2810	7.5	79	0.82	4.9	5.2	2.1	1.8	24
3	M 3LA	2	2860	10.0	80	0.80	6.8	5.7	2.6	2.2	31
4	M 3LB	2	2870	13.3	82	0.81	8.7	5.9	2.7	2.5	39
5.5	M 4SA	2	2890	18.2	83	0.85	11.3	6	2.6	2.2	101
7.5	M 4SB	2	2900	25	84	0.86	15.0	6.4	2.6	2.2	145
9.2	M 4LA	2	2900	30	86	0.87	17.7	6.9	2.8	2.3	178
11	M 4LC	2	2920	36	87	0.86	21	7	2.9	2.5	210
15	M 5SB	2	2930	49	88	0.86	29	7.1	2.6	2.3	340
18.5	M 5SC	2	2930	60	89	0.86	35	7.6	2.7	2.3	420
22	M 5LA	2	2930	72	89	0.87	41	7.8	2.6	2.4	490

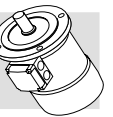

freno c.c. / d.c. brake G.S.-bremse / frein c.c.					
FD					
Mod.	Mb Nm	Z _o 1/h		Jm $\times 10^{-4}$ Kgm ²	IM B9 
		NB	SB		
FD 02	1.75	3900	4800	2.6	4.9
FD 02	1.75	3900	4800	3.0	5.3
FD 02	3.5	3600	4500	3.9	6.5
FD 03	5	2900	4200	5.3	8.5
FD 03	5	1900	3300	6.1	9.6
FD 04	10	1500	3000	10.6	11.9
FD 04	15	1300	2600	13.0	9.9
FD 15	26	1100	2400	28	22
FD 15	26	700	1600	35	25
FD 15	40	450	900	43	28
FD 06	50	—	600	112	46
FD 06	50	—	550	154	53
FD 56	75	—	430	189	64



freno c.a. / a.c. brake W.S.-bremse / frein c.a.				
FA				
Mod.	Mb Nm	Z _o 1/h	Jm $\times 10^{-4}$ kgm ²	IM B9 
FA 02	1.75	4800	3.0	5.1
FA 02	3.5	4500	3.9	6.3
FA 03	5	4200	5.3	8.2
FA 03	5	3300	6.1	9.3
FA 04	10	3000	10.6	12.6
FA 04	15	2600	13.0	14.4
FA 15	26	2400	28	23
FA 15	26	1600	35	26
FA 15	40	900	43	29
FA 06	50	600	112	47
FA 06	50	550	154	54
FA 06	75	430	189	65





4 P**1500 min⁻¹ - S1****50 Hz**

Pn kW		n min ⁻¹	Mn Nm	η %	$\cos \varphi$	In A (400V)	I_s In	$\frac{M_s}{M_n}$	$\frac{M_a}{M_n}$	Jm $\times 10^{-4}$ kgm ²	IM B9 	
0.09	M 0B	4	1350	0.64	52	0.62	0.40	2.6	2.5	2.4	1.5	2.9
0.12	M 05A	4	1310	0.88	51	0.68	0.50	2.6	1.9	1.8	2.0	3.2
0.18	M 05B	4	1320	1.30	53	0.68	0.72	2.6	2.2	2.0	2.3	3.6
0.25	M 05C	4	1320	1.81	60	0.69	0.87	2.7	2.1	1.9	3.3	4.8
0.37	M 1SD	4	1370	2.6	65	0.77	1.07	3.7	2	1.9	6.9	5.5
0.55	M 1LA	4	1380	3.8	69	0.74	1.55	4.1	2.3	2.3	9.1	6.9
0.75	M 2SA	4	1400	5.1	75	0.78	1.85	4.9	2.7	2.5	20	9.2
1.1	M 2SB	4	1400	7.5	75	0.79	2.68	5.1	2.8	2.5	25	10.6
1.5	M 3SA	4	1410	10.2	78	0.77	3.6	4.6	2.1	2.1	34	15.5
2.2	M 3LA	4	1410	14.9	78	0.76	5.4	4.5	2	2	40	17
3	M 3LB	4	1410	20	80	0.78	6.9	5	2.3	2.2	54	21
4	M 3LC	4	1390	27	81	0.79	9.0	4.7	2.3	2.2	61	23
5.5	M 4SA	4	1440	36	84	0.80	11.8	5.5	2.3	2.2	213	42
7.5	M 4LA	4	1440	50	85	0.81	15.7	5.7	2.5	2.4	270	51
9.2	M 4LB	4	1440	61	86	0.81	19.1	5.9	2.7	2.5	319	57
11	M 4 LC	4	1440	73	87	0.82	22.3	5.9	2.7	2.5	360	65
15	M 5SB	4	1460	98	89	0.82	29.7	5.9	2.3	2.1	650	85
18.5	M 5LA	4	1460	121	89	0.81	37.0	6.2	2.6	2.5	790	101

freno c.c. / d.c. brake G.S.-bremse / frein c.c.						freno c.a. / a.c. brake W.S.-bremse / frein c.a.				
FD						FA				
Mod	Mb Nm	Z _o 1/h NB SB		Jm $\times 10^{-4}$ kgm ²	IM B9 	Mod.	Mb Nm	Z _o 1/h	Jm $\times 10^{-4}$ kgm ²	IM B9 
FD 02	1.75	10000	13000	2.6	4.9	FA 02	1.75	13000	2.6	4.7
FD 02	3.5	10000	13000	3.0	5.3	FA 02	3.5	13000	3.0	5.1
FD 02	3.5	7800	10000	3.9	6.5	FA 02	3.5	10000	3.9	6.3
FD 03	5	6000	9400	8.0	8.2	FA 03	5	9400	8.0	7.9
FD 53	7.5	4300	8700	10.2	9.6	FA 03	7.5	8700	10.2	9.3
FD 04	15	4100	7800	22	13.1	FA 04	15	7800	22	13
FD 04	15	2600	5300	27	14.5	FA 04	15	5300	27	14.4
FD 15	26	2800	4900	38	22	FA 15	26	4900	38	23
FD 15	40	2600	4700	44	24	FA 15	40	4700	44	24
FD 15	40	2400	4400	58	27	FA 15	40	4400	58	28
FD 55	55	—	1300	65	29	FA 15	40	1300	65	30
FD 56	75	—	1050	223	55	FA 06	75	1050	223	56
FD 06	100	—	950	280	64	FA 06	100	950	280	65
FD 07	150	—	900	342	73	FA 07	150	900	342	75
FD 07	150	—	850	382	81	FA 07	150	850	382	83
FD 08	200	—	750	725	115	FA 08	200	750	710	114
FD 08	250	—	700	865	131	FA 08	250	700	850	130



Pn kW		n min ⁻¹	Mn Nm	η %	cos φ	In A (400V)	Is In	$\frac{Ms}{Mn}$	$\frac{Ma}{Mn}$	Jm $\times 10^{-4}$ kgm ²	IM B9 
0.09	M 05A	6	880	0.98	41	0.60	2.1	2.1	1.8	3.4	4.3
0.12	M 05B	6	870	1.32	45	0.64	2.1	1.9	1.7	3.7	4.6
0.18	M 1SC	6	900	1.91	56	0.67	2.6	1.9	1.7	8.4	5.1
0.25	M 1SD	6	900	2.7	62	0.82	2.6	1.9	1.7	10.9	6.3
0.37	M 1LA	6	910	3.9	66	1.17	3	2.4	2	12.9	7.3
0.55	M 2SA	6	920	5.7	70	1.64	3.9	2.6	2.2	25	10.6
0.75	M 2SB	6	920	7.8	70	2.38	3.8	2.5	2.2	28	11.5
1.1	M 3SA	6	920	11.4	72	3.2	3.9	2.3	2	33	17
1.5	M 3LA	6	940	15.2	73	4.1	4	2.1	2	82	21
1.85	M 3LB	6	930	19.0	75	4.9	4.5	2.1	2	95	23
2.2	M 3LC	6	930	23	75	6.0	4.6	2	1.9	95	23
3	M 4SA	6	940	30	76	7.5	4.8	1.9	1.8	216	34
4	M 4LA	6	950	40	78	9.6	5.5	2	1.8	295	43
5.5	M 4LB	6	945	56	80	12.7	5.9	2.1	1.9	383	54
7.5	M 5SA	6	955	75	84	15.9	5.9	2.2	2	740	69
11	M 5SB	6	960	109	87	22.5	6.5	2.5	2.3	970	89

freno c.c. / d.c. brake G.S.-bremse / frein c.c.					
FD					
Mod.	Mb Nm	Zo 1/h		Jm $\times 10^{-4}$ kgm ²	IM B9 
		NB	SB		
FD 02	3.5	9000	14000	4.0	6.0
FD 02	3.5	9000	14000	4.3	6.3
FD 03	5	8100	13500	9.5	7.8
FD 03	5	7800	13000	12	9
FD 53	7.5	5100	9500	14	10
FD 04	15	4800	7200	27	14.5
FD 04	15	3400	6400	30	15.4
FD 05	26	2700	5000	37	23
FD 15	40	1900	4100	86	27
FD 15	40	1700	3600	99	29
FD 55	55	—	1900	99	29
FD 56	75	—	1400	226	47
FD 06	100	—	1200	305	56
FD 07	150	—	1050	406	70
FD 08	170	—	900	815	98
FD 08	200	—	800	1045	119

freno c.a. / a.c. brake W.S.-bremse / frein c.a.				
FA				
Mod.	Mb Nm	Zo 1/h	Jm $\times 10^{-4}$ kgm ²	IM B9 
FA 02	3.5	14000	4.3	6.1
FA 03	5	13500	9.5	7.5
FA 03	5	13000	12	8.7
FA 03	7.5	9500	14	9.7
FA 04	15	7200	27	14.4
FA 04	15	6400	30	15.3
FA 15	26	5000	37	24
FA 15	40	4100	86	28
FA 15	40	3600	99	30
FA 15	55	1900	99	30
FA 06	75	1400	226	48
FA 06	100	1200	305	57
FA 07	150	1050	406	72
FA 08	170	900	800	98
FA 08	200	800	1030	118





2/4 P**3000/1500 min⁻¹ - S1****50 Hz**

Pn kW		n min ⁻¹	Mn Nm	η %	cos φ	In A (400V)	Is In	Ms Mn	Ma Mn	Jm x 10 ⁻⁴ kgm ²	IM B9 	
0.20 0.15	M 05A	2	2700	0.71	55	0.82	0.64	3.5	2.1	1.9	2.9	4.1
		4	1350	1.06	49	0.67	0.66	2.6	1.8	1.7		
0.28 0.20	M 1SB	2	2700	0.99	56	0.82	0.88	2.9	1.9	1.7	4.7	4
		4	1370	1.39	59	0.68	1.02	3.1	1.8	1.7		
0.37 0.25	M 1SC	2	2740	1.29	56	0.82	1.16	3.5	1.8	1.8	5.8	4.7
		4	1390	1.72	60	0.73	0.82	3.3	2	1.9		
0.45 0.30	M 1SD	2	2780	1.55	63	0.85	1.21	3.8	1.8	1.8	6.9	5.5
		4	1400	2.0	63	0.74	0.93	3.8	2.1	1.9		
0.55 0.37	M 1LA	2	2800	1.9	73	0.79	1.38	4.2	2	1.8	9.1	6.9
		4	1400	2.5	68	0.72	1.09	3.9	2.2	2		
0.75 0.55	M 2SA	2	2780	2.6	65	0.85	1.96	3.8	1.9	1.8	20	9.2
		4	1400	3.8	68	0.81	1.44	3.9	1.7	1.7		
1.1 0.75	M 2SB	2	2730	3.9	65	0.86	2.84	3.9	2	1.9	25	10.7
		4	1410	5.1	75	0.81	1.78	4.5	2.1	2		
1.5 1.1	M 3SA	2	2830	5.1	74	0.83	3.5	4.7	2.1	2	34	15.5
		4	1420	7.4	77	0.78	2.6	4.3	2.1	2		
2.2 1.5	M 3LA	2	2800	7.5	72	0.85	5.2	4.5	2	1.9	40	17
		4	1410	10.2	73	0.79	3.8	4.7	2	2		
3.5 2.5	M 3LB	2	2850	11.7	80	0.84	7.5	5.4	2.2	2.1	61	23
		4	1420	16.8	82	0.80	5.5	5.2	2.2	2.2		
4.8 3.8	M 4 SA	2	2900	15.8	81	0.88	9.7	6	2	1.9	213	42
		4	1430	25.4	81	0.84	8.1	5.2	2.1	2.1		
5.5 4.4	M 4SB	2	2890	18.2	80	0.87	11.4	5.9	2.4	2	213	42
		4	1440	29	82	0.84	9.2	5.3	2.2	2		
7.5 6	M 4LA	2	2900	25	82	0.87	15.2	6.5	2.4	2	270	51
		4	1430	40	84	0.85	12.1	5.8	2.3	2.1		
9.2 7.3	M 4LB	2	2920	30	83	0.86	18.6	6	2.6	2.2	319	57
		4	1440	48	85	0.85	14.6	5.5	2.3	2.1		

freno c.c. / d.c. brake G.S.-bremse / frein c.c.					
FD					
Mod.	Mb Nm	Z _o 1/h		Jm x 10 ⁻⁴ kgm ²	IM B9 
		NB	SB		
FD 02	3.5	2200	2600	3.5	5.8
		4000	5100		
FD 03	3.5	2100	2400	5.8	6.7
		3800	4800		
FD 03	5	1400	2100	6.9	7.4
		2900	4200		
FD 03	5	1400	2100	8	8.2
		2900	4200		
FD 03	5	1600	2200	10.2	9.6
		3300	4600		
FD 04	10	1400	1600	22	13.1
		2700	3600		
FD 04	10	1200	1500	27	14.5
		2300	3100		
FD 15	26	700	1000	38	22
		1600	2600		
FD 15	26	600	900	44	24
		1300	2300		
FD 15	40	500	900	65	29
		1000	2100		
FD 06	50	—	400	233	55
		—	950		
FD 56	75	—	350	223	55
		—	900		
FD 06	100	—	350	280	64
		—	950		
FD 07	150	—	300	342	73
		—	800		

freno c.a. / a.c. brake W.S.-bremse / frein c.a.				
FA				
Mod.	Mb Nm	Z _o 1/h	Jm x 10 ⁻⁴ kgm ²	IM B9 
FA 03	3.5	2400	5.8	6.4
		4800		
FA 03	5	2100	6.9	7.1
		4200		
FA 03	5	2100	8	7.9
		4200		
FA 03	5	2200	10.2	9.3
		4600		
FA 04	10	1600	22	13
		3600		
FA 04	10	1500	27	14.5
		3100		
FA 15	26	1000	38	23
		2600		
FA 15	26	900	44	24
		2300		
FA 15	40	900	65	30
		2100		
FA 06	50	400	233	56
		950		
FA 06	75	350	223	56
		900		
F 06	100	350	280	65
		950		
FA 07	150	300	342	75
		800		



Pn kW		n min ⁻¹	Mn Nm	η %	cos φ	In A (400V)	$\frac{I_s}{I_n}$	$\frac{M_s}{M_n}$	$\frac{M_a}{M_n}$	Jm x 10 ⁻⁴ kgm ²	IM B9 	
0.25 0.08	M 1SA	2	2850	0.84	60	0.82	0.73	4.3	1.9	1.8	6.9	5.5
		6	910	0.84	43	0.70	0.38	2.1	1.4	1.5		
0.37 0.12	M 1LA	2	2880	1.23	62	0.80	1.08	4.4	1.9	1.8	9.1	6.9
		6	900	1.27	44	0.73	0.54	2.4	1.4	1.5		
0.55 0.18	M 2SA	2	2800	1.88	63	0.86	1.47	4.5	1.9	1.7	20	9.2
		6	930	1.85	52	0.65	0.77	3.3	2.0	1.9		
0.75 0.25	M 2SB	2	2800	2.6	66	0.87	1.89	4.3	1.8	1.6	25	10.6
		6	930	2.6	54	0.67	1.00	3.2	1.7	1.8		
1.1 0.37	M 3SA	2	2870	3.7	71	0.82	2.73	4.9	1.8	1.9	34	15.5
		6	930	3.8	63	0.70	1.21	3.1	1.5	1.8		
1.5 0.55	M 3LA	2	2880	5.0	73	0.84	3.53	5.1	1.9	2.0	40	17
		6	940	5.6	64	0.67	1.85	3.5	1.7	1.8		
2.2 0.75	M 3LB	2	2900	7.2	77	0.85	4.9	5.9	2.0	2.0	61	23
		6	950	7.5	67	0.64	2.5	3.3	1.9	1.8		
3 1.1	M 4SA	2	2910	9.9	74	0.88	6.6	5.6	2.0	2.1	170	36
		6	960	10.9	73	0.68	3.2	4.5	2.2	2		
4.5 1.5	M 4SB	2	2910	14.8	78	0.84	9.9	5.8	1.9	1.8	213	42
		6	960	14.9	74	0.67	4.4	4.2	1.9	2.0		
5.5 2.2	M 4LA	2	2920	18.0	78	0.87	11.7	6.2	2.1	1.9	270	51
		6	960	22	77	0.71	5.8	4.3	2.1	2.0		

freno c.c. / d.c. brake G.S.-bremse / frein c.c.					
FD					
Mod.	Mb Nm	Z _o 1/h		Jm x 10 ⁻⁴ kgm ²	IM B9 
		NB	SB		
FD 03	1.75	1500	1700	8	8.2
		10000	13000		
FD 03	3.5	1000	1300	10.2	9.6
		9000	11000		
FD 04	5	1500	1800	22	13.1
		4100	6300		
FD 04	5	1700	1900	27	14.5
		3800	6000		
FD 15	13	1000	1300	38	22
		3500	5000		
FD 15	13	1000	1200	44	24
		2900	4000		
FD 15	26	700	900	65	29
		2100	3000		
FD 56	37	—	600	182	48
		—	2200		
FD 56	37	—	500	223	55
		—	2100		
FD 06	50	—	400	280	64
		—	1900		

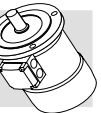
freno c.a. / a.c. brake W.S.-bremse / frein c.a.				
FA				
Mod.	Mb Nm	Z _o 1/h	Jm x 10 ⁻⁴ kgm ²	IM B9 
FA 03	3.5	1300	10.2	9.3
		11000		
FA 04	5	1800	22	13
		6300		
FA 04	5	1900	27	14.4
		6000		
FA 15	13	1300	38	23
		5000		
FA 15	13	1200	44	24
		4000		
FA 15	26	900	65	30
		3000		
FA 06	37	600	182	50
		2200		
FA 06	37	500	223	56
		2100		
FA 06	50	400	280	65
		1900		





2/8 P**3000/750 min⁻¹ - S3 60/40%****50 Hz**

Pn kW		n min ⁻¹	Mn Nm	η %	cos φ	In A (400V)	Is In	Ms Mn	Ma Mn	Jm x 10 ⁻⁴ kgm ²	IM B9 	
0.37 0.09	M 1LA	2	2800	1.26	63	0.86	0.99	3.9	1.8	1.9	12.9	7.3
		8	670	1.28	34	0.75	0.51	1.8	1.4	1.5		
0.55 0.13	M 2SA	2	2830	1.86	66	0.86	1.40	4.4	2.1	2	20	9.2
		8	690	1.80	41	0.64	0.72	2.3	1.6	1.7		
0.75 0.18	M 2SB	2	2800	2.6	68	0.88	1.81	4.6	2.1	2	25	10.6
		8	690	2.5	43	0.66	0.92	2.3	1.6	1.7		
1.1 0.28	M 3SA	2	2870	3.7	69	0.84	2.74	4.6	1.8	1.7	34	15.5
		8	690	3.9	44	0.56	1.64	2.3	1.4	1.7		
1.5 0.37	M 3LA	2	2880	5.0	69	0.85	3.69	4.7	1.9	1.8	40	17
		8	690	5.1	46	0.63	1.84	2.1	1.6	1.6		
2.4 0.55	M 3LB	2	2900	7.9	75	0.82	5.6	5.4	2.1	2	61	23
		8	700	7.5	54	0.58	2.5	2.6	1.8	1.8		
3 0.75	M 4SA	2	2920	9.8	72	0.85	7.1	5.6	2	1.8	162	36
		8	710	10.1	61	0.64	2.8	3	1.7	1.8		
4 1	M 4SB	2	2870	13.3	73	0.84	9.4	5.6	2.3	2.4	213	42
		8	690	13.8	66	0.62	3.5	2.9	1.9	1.8		
5.5 1.5	M 4LA	2	2870	18.3	75	0.84	12.6	6.1	2.4	2.5	270	51
		8	690	21	68	0.63	5.1	2.9	1.9	1.9		

freno c.c. / d.c. brake G.S.-bremse / frein c.c.					
FD					
Mod.	Mb Nm	Z _o 1/h		Jm x 10 ⁻⁴ kgm ²	IM B9 
		NB	SB		
FD 03	3.5	1200 9500	1300 13000	14	10
FD 04	5	1500 5600	1800 8000	22	13.1
FD 04	10	1700 4800	1900 7300	27	14.5
FD 15	13	1000 3400	1300 5000	38	22
FD 15	13	1000 3300	1200 5000	44	24
FD 15	26	550 2000	700 3500	65	29
FD 56	37	— —	600 3400	182	48
FD 56	37	— —	500 3500	223	55
FD 06	50	— —	400 2400	280	64

freno c.a. / a.c. brake W.S.-bremse / frein c.a.				
FA				
Mod.	Mb Nm	Z _o 1/h	Jm x 10 ⁻⁴ kgm ²	IM B9 
FA 04	5	1800 8000	22	13
FA 04	10	1900 7300	27	14.4
FA 15	13	1300 5000	38	23
FA 15	13	1200 5000	44	24
FA 15	26	700 3500	65	30
FA 06	37	600 3400	182	50
FA 06	37	500 3500	223	56
FA 06	50	400 2400	280	65

Pn kW		n min ⁻¹	Mn Nm	η %	cos φ	In A (400V)	$\frac{I_s}{I_n}$	$\frac{M_s}{M_n}$	$\frac{M_a}{M_n}$	Jm $\times 10^{-4}$ kgm ²	IM B9 	
0.55 0.09	M 2SA	2	2820	1.86	64	0.89	1.39	4.2	1.6	1.7	25	10.6
		12	430	2.0	30	0.63	0.69	1.8	1.9	1.8		
0.75 0.12	M 3SA	2	2900	2.5	65	0.81	2.06	5.2	1.9	2.1	34	15.5
		12	460	2.5	33	0.43	1.22	1.9	1.3	1.6		
1.1 0.18	M 3LA	2	2850	3.7	65	0.85	2.87	4.5	1.6	1.8	40	17
		12	430	4.0	26	0.54	1.85	1.5	1.3	1.5		
1.5 0.25	M 3LB	2	2900	4.9	67	0.86	3.76	5.6	1.9	1.9	54	21
		12	440	5.4	36	0.46	2.18	1.8	1.7	1.8		
2 0.3	M 3LC	2	2850	6.7	70	0.84	4.9	4.9	1.8	1.7	61	23
		12	450	6.4	38	0.47	2.4	1.7	1.6	1.7		
3 0.5	M 4SA	2	2920	9.8	74	0.87	6.7	6.8	2.3	1.9	213	42
		12	470	10.2	51	0.43	3.3	2	1.7	1.6		
4 0.7	M 4LA	2	2920	13.1	75	0.89	8.6	5.9	2.4	2.3	270	51
		12	460	14.5	53	0.44	4.3	1.9	1.7	1.6		

freno c.c. / d.c. brake G.S.-bremse / frein c.c.					
FD					
Mod.	Mb Nm	Z _o 1/h		Jm $\times 10^{-4}$ kgm ²	IM B9 
		NB	SB		
FD 04	5	1000	1300	27	14.5
		8000	12000		
FD 15	13	700	900	38	22
		5000	7000		
FD 15	13	700	900	44	24
		4000	6000		
FD 15	13	700	900	58	27
		3800	5000		
FD 55	18	—	700	65	29
		—	3500		
FD 56	37	—	450	223	55
		—	3000		
FD 56	37	—	400	280	64
		—	2800		

freno c.a. / a.c. brake W.S.-bremse / frein c.a.				
FA				
Mod.	Mb Nm	Z _o 1/h	Jm $\times 10^{-4}$ kgm ²	IM B9 
FA 15	13	900	38	23
		7000		
FA 15	13	900	44	24
		6000		
FA 15	13	900	58	28
		5000		
FA 15	18	700	65	30
		3500		
FA 06	37	450	223	56
		3000		
FA 06	37	400	280	65
		2800		

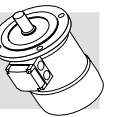

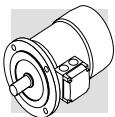

M12 - DIMENSIONI MOTORI

M12 - MOTORS DIMENSIONS

M12 - MOTORENABMESSUN-
GEN

M12 - DIMENSIONS
MOTEURS

BN

IM B14

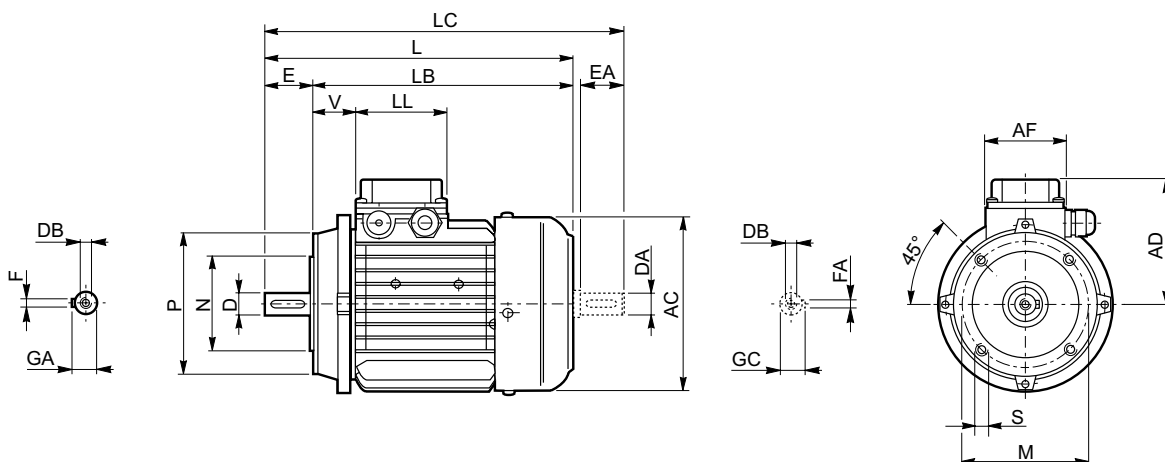

	Albero / Shaft / Welle / Arbre					Flangia / Flange / Flansch / Bride					Motore / Motor / Motor / Moteur							
	D DA	E EA	DB	GA GC	F FA	M	N	P	S	T	AC	L	LB	LC	AD	AF	LL	V
BN 56	9	20	M3	10.2	3	65	50	80	M5	2.5	110	185	165	207	91	74	80	34
BN 63	11	23	M4	12.5	4	75	60	90	M5	2.5	121	207	184	232	95	74	80	26
BN 71	14	30	M5	16	5	85	70	105	M6	2.5	138	249	219	281	108	74	80	37
BN 80	19	40	M6	21.5	6	100	80	120	M6	3	156	274	234	315	119	74	80	38
BN 90 S	24	50	M8	27	8	115	95	140	M8	3	176	326	276	378	133	98	98	44
BN 90 L	24	50	M8	27	8	115	95	140	M8	3	176	326	276	378	133	98	98	44
BN 100	28	60	M10	31	8	130	110	160	M8	3.5	195	366	306	429	142	98	98	50
BN 112	28	60	M10	31	8	130	110	160	M8	3.5	219	385	325	448	157	98	98	52
BN 132 S	38	80	M12	41	10	165	130	200	M10	4	258	455	375	538	193	118	118	58
BN 132 M	38	80	M12	41	10	165	130	200	M10	4	258	493	413	576	193	118	118	58

N.B.:

1) Queste dimensioni sono riferite alla seconda estremità d'albero.

NOTE:

1) These values refer to the rear shaft end.

HINWEIS:

1) Diese Maße betreffen das zweite Wellenende.

REMARQUE :

1) Ces dimensions se réfèrent à la deuxième extrémité de l'arbre.

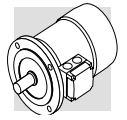

BN

IM B5

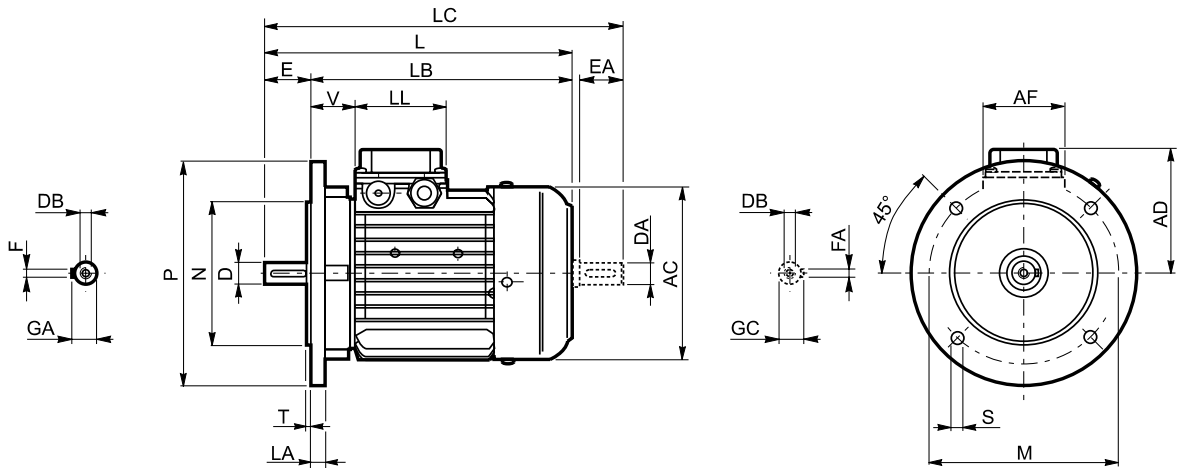

	Albero / Shaft / Welle / Arbre					Flangia / Flange / Flansch / Bride						Motore / Motor / Motor / Moteur							
	D DA	E EA	DB	GA GC	F FA	M	N	P	S	T	LA	AC	L	LB	LC	AD	AF	LL	V
BN 56	9	20	M3	10.2	3	100	80	120	7	3	8	110	185	165	207	91	74	80	34
BN 63	11	23	M4	12.5	4	115	95	140	9.5	3	10	121	207	184	232	95	74	80	26
BN 71	14	30	M5	16	5	130	110	160	9.5	3	10	138	249	219	281	108	74	80	37
BN 80	19	40	M6	21.5	6	165	130	200	11.5	3.5	11.5	156	274	234	315	119	74	80	38
BN 90 S	24	50	M8	27	8	165	130	200	11.5	3.5	11.5	176	326	276	378	133	98	98	44
BN 90 L	24	50	M8	27	8	165	130	200	11.5	3.5	11.5	176	326	276	378	133	98	98	44
BN 100	28	60	M10	31	8	215	180	250	14	4	14	195	367	307	429	142	98	98	50
BN 112	28	60	M10	31	8	215	180	250	14	4	15	219	385	325	448	157	98	98	52
BN 132 S	38	80	M12	41	10	265	230	300	14	4	16	258	455	375	538	193	118	118	58
BN 132 M	38	80	M12	41	10	265	230	300	14	4	16	258	493	413	576	193	118	118	58
BN 160 MR	42 38 (1)	110 80 (1)	M16 M12 (1)	45 41 (1)	12 10 (1)	300	250	350	18.5	5	15	258	562	452	645	193	118	118	218
BN 160 M	42 38 (1)	110 80 (1)	M16 M12 (1)	45 41 (1)	12 10 (1)	300	250	350	18.5	5	15	310	596	486	680	245	187	187	51
BN 160 L	42 38 (1)	110 80 (1)	M16 M12 (1)	45 41 (1)	12 10 (1)	300	250	350	18.5	5	15	310	596	486	680	245	187	187	51
BN 180 M	48 38 (1)	110 110 (1)	M16 M12 (1)	51.5 41 (1)	14 10 (1)	300	250	350	18.5	5	15	310	640	530	724	245	187	187	51
BN 180 L	48 42 (1)	110 110 (1)	M16 M16 (1)	51.5 45 (1)	14 12 (1)	300	250	350	18.5	5	18	348	708	598	823	261	187	187	52
BN 200 L	55 42 (1)	110 110 (1)	M20 M16 (1)	59 45 (1)	16 12 (1)	350	300	400	18.5	5	18	348	722	612	837	261	187	187	66

N.B.:

1) Queste dimensioni sono riferite alla seconda estremità d'albero.

NOTE:

1) These values refer to the rear shaft end.

HINWEIS:

1) Diese Maße betreffen das zweite Wellenende.

REMARQUE :

1) Ces dimensions se réfèrent à la deuxième extrémité de l'arbre.

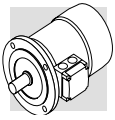

BN_FD

IM B14

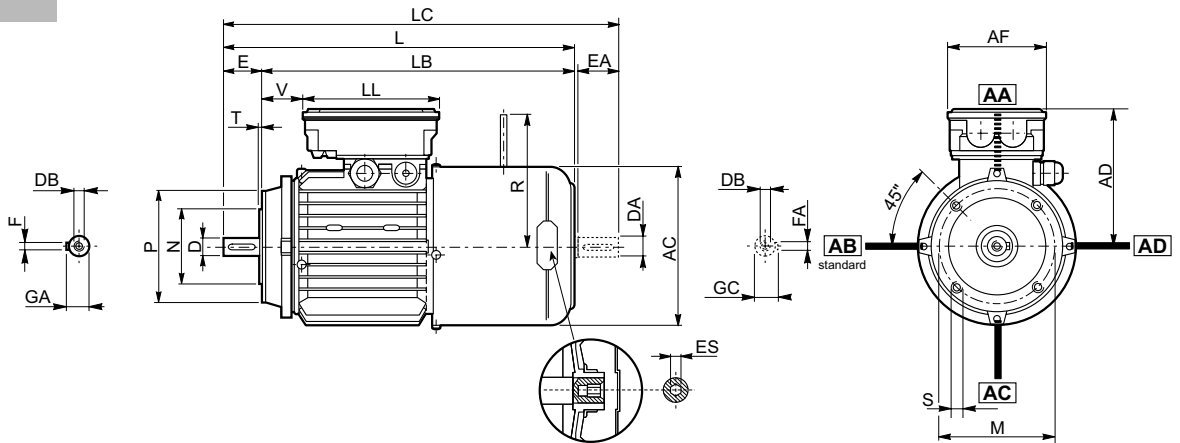

	Albero / Shaft / Welle / Arbre					Flangia / Flange / Flansch / Bride					Motore / Motor / Motor / Moteur									
	D DA	E EA	DB	GA GC	F FA	M	N	P	S	T	AC	L	LB	LC	AD	AF	LL	V	R	ES
BN 63	11	23	M4	12.5	4	75	60	90	M5	2.5	121	272	249	297	119	98	133	14	96	5
BN 71	14	30	M5	16	5	85	70	105	M6	2.5	138	310	280	342	132	98	133	30	103	5
BN 80	19	40	M6	21.5	6	100	80	120	M6	3	156	346	306	388	143	98	133	41	129	5
BN 90 S	24	50	M8	27	8	115	95	140	M8	3	176	409	359	461	146	110	165	39	129	6
BN 90 L	24	50	M8	27	8	115	95	140	M8	3	176	409	359	461	146	110	165	39	160	6
BN 100	28	60	M10	31	8	130	110	160	M8	3.5	195	458	398	521	155	110	165	62	160	6
BN 112	28	60	M10	31	8	130	110	160	M8	3.5	219	484	424	547	170	110	165	73	199	6
BN 132 S	38	80	M12	41	10	165	130	200	M10	4	258	565	485	648	193	118	118	142	204 (2)	6
BN 132 M	38	80	M12	41	10	165	130	200	M10	4	258	603	523	686	193	118	118	180	204 (2)	6

N.B.:

- 1) Queste dimensioni sono riferite alla seconda estremità d'albero.
- 2) Per freno FD07 quota R=226.

NOTE:

- 1) These values refer to the rear shaft end.
- 2) For FD07 brake value R=226.

HINWEIS:

- 1) Diese Maße betreffen das zweite Wellenende.
- 2) Für Bremse FD07, Maß R=226.

REMARQUE :

- 1) Ces dimensions se réfèrent à la deuxième extrémité de l'arbre.
- 2) Pour frein FD07 valeur R=226.

L'esagono ES non è presente con l'opzione PS.

ES hexagon is not supplied with PS option.

Der Sechskant ES ist bei der Option PS nicht vorhanden.

L'hexagone ES n'est pas disponible avec l'option PS.

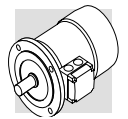

BN_FD

IM B5

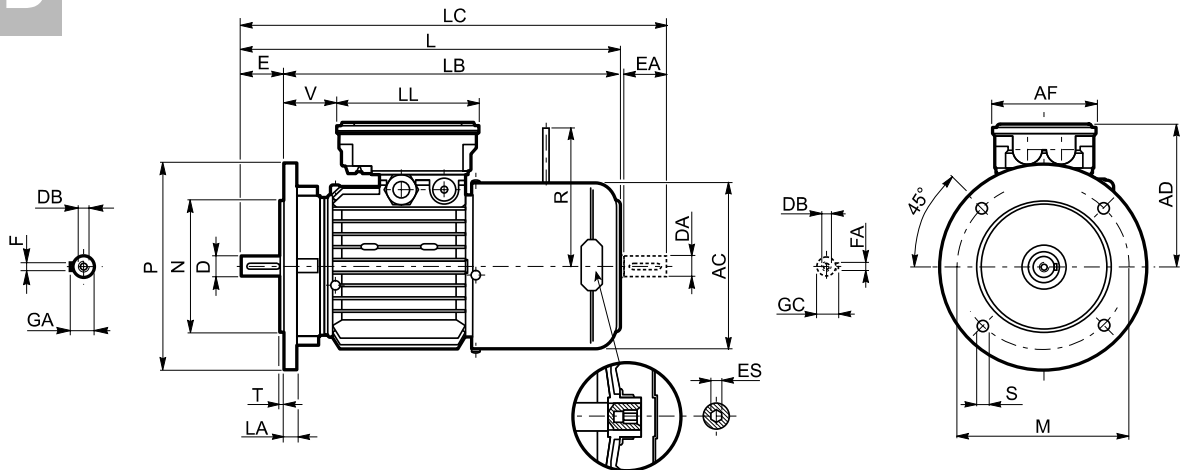

	Albero / Shaft / Welle / Arbre					Flangia / Flange / Flansch / Bride						Motore / Motor / Motor / Moteur									
	D DA	E EA	DB	GA GC	F FA	M	N	P	S	T	LA	AC	L	LB	LC	AD	AF	LL	V	R	ES
BN 63	11	23	M4	12.5	4	115	95	140	9.5	3	10	121	272	249	297	119	98	133	14	96	5
BN 71	14	30	M5	16	5	130	110	160	9.5	3.5	10	138	310	280	342	132	98	133	30	103	5
BN 80	19	40	M6	21.5	6	165	130	200	11.5	3.5	11.5	156	346	306	388	143	98	133	41	129	5
BN 90 S	24	50	M8	27	8	165	130	200	11.5	3.5	11.5	176	409	359	461	146	110	165	39	129	6
BN 90 L	24	50	M8	27	8	165	130	200	11.5	3.5	11.5	176	409	359	461	146	110	165	39	160	6
BN 100	28	60	M10	31	8	215	180	250	14	4	14	195	458	398	521	155	110	165	62	160	6
BN 112	28	60	M10	31	8	215	180	250	14	4	15	219	484	424	547	170	110	165	73	199	6
BN 132 S	38	80	M12	41	10	265	230	300	14	4	16	258	565	485	648	193	118	118	142	204 (2)	6
BN 132 M	38	80	M12	41	10	265	230	300	14	4	16	258	603	523	686	193	118	118	180	204 (2)	6
BN 160 MR	42 38 (1)	110 80 (1)	M16 M12 (1)	45 41 (1)	12 10 (1)	300	250	350	18.5	5	15	258	672	562	755	193	118	118	218	226	6
BN 160 M	42 38 (1)	110 80 (1)	M16 M12 (1)	45 41 (1)	12 10 (1)	300	250	350	18.5	5	15	310	736	626	820	245	187	187	51	266	
BN 160 L	42 38 (1)	110 80 (1)	M16 M12 (1)	45 41 (1)	12 10 (1)	300	250	350	18.5	5	15	310	736	626	820	245	187	187	51	266	
BN 180 M	48 38 (1)	110 110 (1)	M16 M12 (1)	51.5 41 (1)	14 10 (1)	300	250	350	18.5	5	15	310	780	670	864	245	187	187	51	266	
BN 180 L	48 42 (1)	110 110 (1)	M16 M16 (1)	51.5 45 (1)	14 12 (1)	300	250	350	18.5	5	18	348	866	756	981	261	187	187	52	305	
BN 200 L	55 42 (1)	110 110 (1)	M20 M16 (1)	59 45 (1)	16 12 (1)	350	300	400	18.5	5	18	348	878	768	993	261	187	187	64	305	

N.B.:

- 1) Queste dimensioni sono riferite alla seconda estremità d'albero.
- 2) Per freno FD07 quota R=226.

NOTE:

- 1) These values refer to the rear shaft end.
- 2) For FD07 brake value R=226.

HINWEIS:

- 1) Diese Maße betreffen das zweite Wellenende.
- 2) Für Bremse FD07, Maß R=226.

REMARQUE :

- 1) Ces dimensions se réfèrent à la deuxième extrémité de l'arbre.
- 2) Pour frein FD07 valeur R=226.

L'esagono ES non è presente con l'opzione PS.

ES hexagon is not supplied with PS option.

Der Sechskant ES ist bei der Option PS nicht vorhanden.

L'hexagone ES n'est pas disponible avec l'option PS.

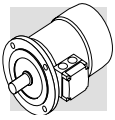

BN_FA

IM B14

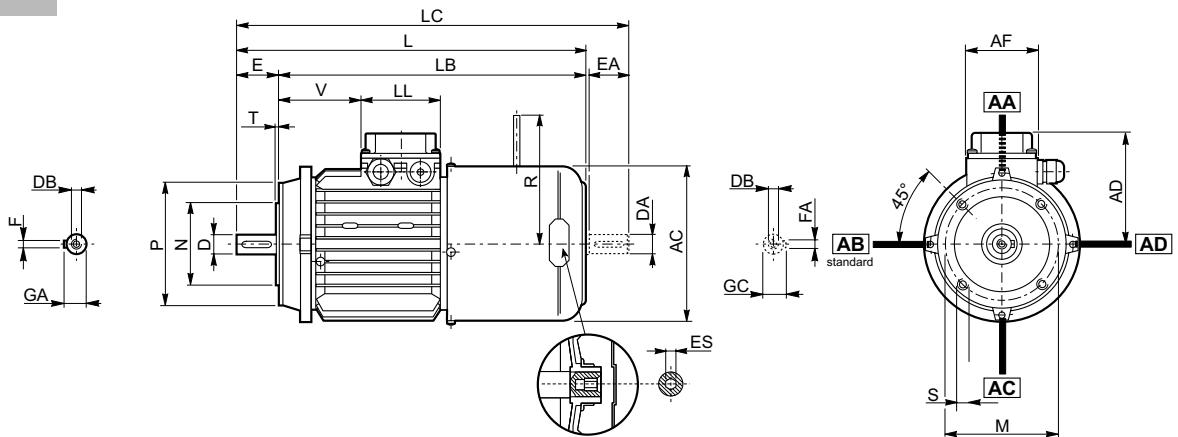

	Albero / Shaft / Welle / Arbre					Flangia / Flange / Flansch / Bride					Motore / Motor / Motor / Moteur									
	D DA	E EA	DB	GA GC	F FA	M	N	P	S	T	AC	L	LB	LC	AD	AF	LL	V	R	ES
BN 63	11	23	M4	12.5	4	75	60	90	M5	2.5	121	272	249	119	95	74	80	26	116	5
BN 71	14	30	M5	16	5	85	70	105	M6	2.5	138	310	280	342	108	74	80	68	124	5
BN 80	19	40	M6	21.5	6	100	80	120	M6	3	156	346	306	388	119	74	80	83	134	5
BN 90 S	24	50	M8	27	8	115	95	140	M8	3	176	409	359	461	133	98	98	95	134	6
BN 90 L	24	50	M8	27	8	115	95	140	M8	3	176	409	359	461	133	98	98	95	160	6
BN 100	28	60	M10	31	8	130	110	160	M8	3.5	195	458	398	521	142	98	98	119	160	6
BN 112	28	60	M10	31	8	130	110	160	M8	3.5	219	484	424	547	157	98	98	128	198	6
BN 132 S	38	80	M12	41	10	165	130	200	M10	4	258	565	485	648	193	118	118	142	200 (2)	6
BN 132 M	38	80	M12	41	10	165	130	200	M10	4	258	603	523	686	193	118	118	180	200 (2)	6

N.B.:

- 1) Queste dimensioni sono riferite alla seconda estremità d'albero.
- 2) Per freno FD07 quota R=226.

NOTE:

- 1) These values refer to the rear shaft end.
- 2) For FD07 brake value R=226.

HINWEIS:

- 1) Diese Maße betreffen das zweite Wellenende.
- 2) Für Bremse FD07, Maß R=226.

REMARQUE :

- 1) Ces dimensions se réfèrent à la deuxième extrémité de l'arbre.
- 2) Pour frein FD07 valeur R=226.

Per la versione BN..FA le dimensioni della scatola morsettieria AD, AF, LL, V sono uguali al tipo BN..FD.

For motors type BN..FA, the terminal box sizes AD, AF, LL, V are the same as for BN..FD.

Bei der Motor typ BN..FA sind die Maße des Klemmenkastens AD, AF, LL, V denen der Version BN..FD gleich.

Pour moteurs type BN..FA les dimensions de la boîte à bornes AD, AF, LL, V sont les mêmes de BN..FD.

L'esagono ES non è presente con l'opzione PS.

ES hexagon is not supplied with PS option.

Der Sechskant ES ist bei der Option PS nicht vorhanden.

L'hexagone ES n'est pas disponible avec l'option PS.

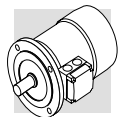

BN_FA

IM B5

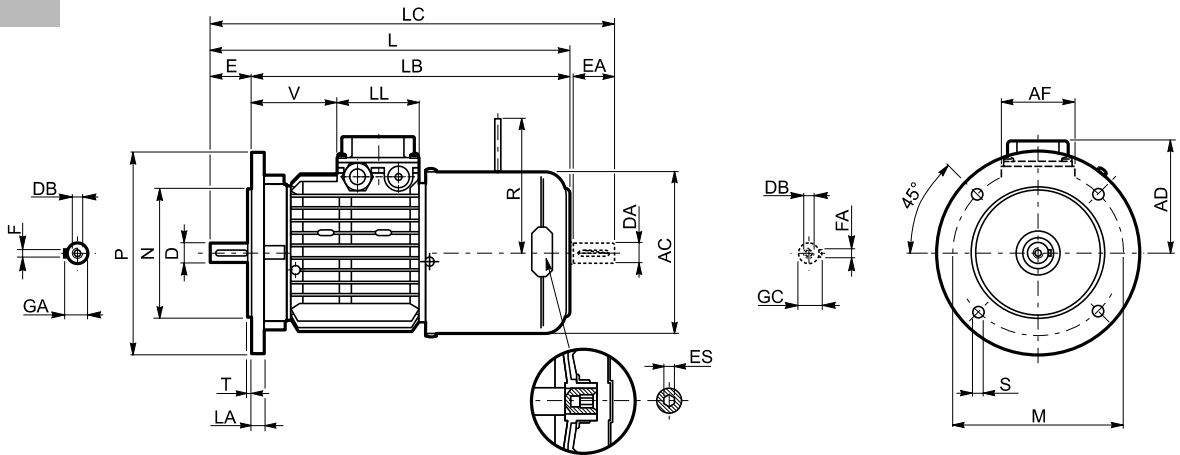

	Albero / Shaft / Welle / Arbre					Flangia / Flange / Flansch / Bride						Motore / Motor / Motor / Moteur									
	D DA	E EA	DB	GA GC	F FA	M	N	P	S	T	LA	AC	L	LB	LC	AD	AF	LL	V	R	ES
BN 63	11	23	M4	12.5	4	115	95	140	9.5	3	10	121	272	249	297	95	74	80	26	116	5
BN 71	14	30	M5	16	5	130	110	160	9.5	3.5	10	138	310	280	342	108	74	80	68	124	5
BN 80	19	40	M6	21.5	6	165	130	200	11.5	3.5	11.5	156	346	306	388	119	74	80	83	134	5
BN 90 S	24	50	M8	27	8	165	130	200	11.5	3.5	11.5	176	409	359	461	133	98	98	95	134	6
BN 90 L	24	50	M8	27	8	165	130	200	11.5	3.5	11.5	176	409	359	461	133	98	98	95	160	6
BN 100	28	60	M10	31	8	215	180	250	14	4	14	195	458	398	521	142	98	98	119	160	6
BN 112	28	60	M10	31	8	215	180	250	14	4	15	219	484	424	547	157	98	98	128	198	6
BN 132 S	38	80	M12	41	10	265	230	300	14	4	16	258	565	485	648	193	118	118	142	200 (2)	6
BN 132 M	38	80	M12	41	10	265	230	300	14	4	16	258	603	523	686	193	118	118	180	200 (2)	6
BN 160 MR	42 38 (1)	110 80 (1)	M16 M12 (1)	45 41 (1)	12 10 (1)	300	250	350	18.5	5	15	258	672	562	755	193	118	118	218	217	6
BN 160 M	42 38 (1)	110 80 (1)	M16 M12 (1)	45 41 (1)	12 10 (1)	300	250	350	18.5	5	15	310	736	626	820	245	187	187	51	247	—
BN 160 L	42 38 (1)	110 80 (1)	M16 M12 (1)	45 41 (1)	12 10 (1)	300	250	350	18.5	5	15	310	736	626	820	245	187	187	51	247	—
BN 180 M	48 38 (1)	110 80 (1)	M16 M12 (1)	51.5 41 (1)	14 10 (1)	300	250	350	18.5	5	15	310	780	670	864	245	187	187	51	247	—

N.B.:

- 1) Queste dimensioni sono riferite alla seconda estremità d'albero.
- 2) Per freno FD07 quota R=226.

NOTE:

- 1) These values refer to the rear shaft end.
- 2) For FD07 brake value R=226.

HINWEIS:

- 1) Diese Maße betreffen das zweite Wellenende.
- 2) Für Bremse FD07, Maß R=226.

REMARQUE :

- 1) Ces dimensions se réfèrent à la deuxième extrémité de l'arbre.
- 2) Pour frein FD07 valeur R=226.

Per la versione BN..FA le dimensioni della scatola morsettieria AD, AF, LL, V sono uguali al tipo BN..FD.

For motors type BN..FA, the terminal box sizes AD, AF, LL, V are the same as for BN..FD.

Bei der Motor typ BN..FA sind die Maße des Klemmenkastens AD, AF, LL, V denen der Version BN..FD gleich.

Pour moteurs type BN..FA les dimensions de la boîte à bornes AD, AF, LL, V sont les mêmes de BN..FD.

L'esagono ES non è presente con l'opzione PS.

ES hexagon is not supplied with PS option.

Der Sechskant ES ist bei der Option PS nicht vorhanden.

L'hexagone ES n'est pas disponible avec l'option PS.

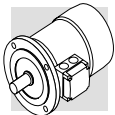

BN_BA

IM B14

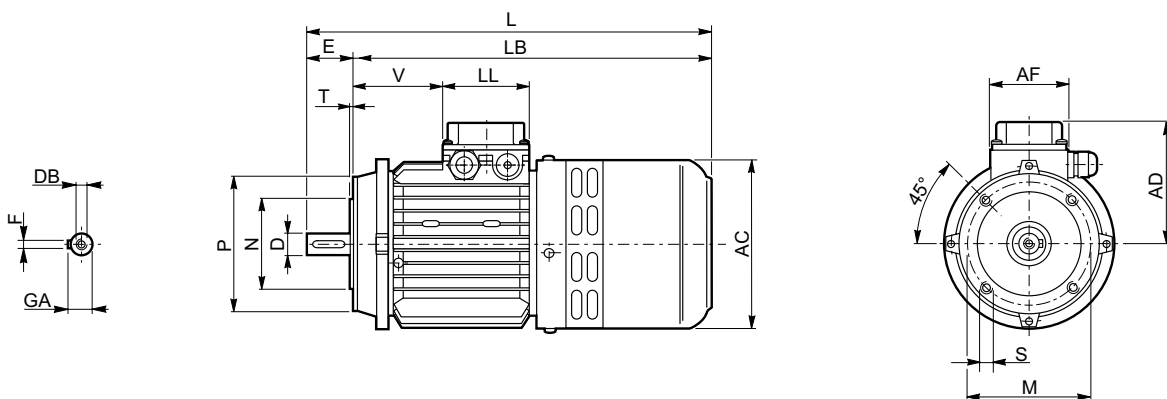

	Albero / Shaft / Welle / Arbre					Flangia / Flange / Flansch / Bride					Motore / Motor / Motor / Moteur						
	D DA	E EA	DB	GA GC	F FA	M	N	P	S	T	AC	L	LB	AD	AF	LL	V
BN 63	11	23	M4	12.5	4	75	60	90	M5	2.5	124	298	275	95	74	80	28
BN 71	14	30	M5	16	5	85	70	105	M6	2.5	138	327	297	108	74	80	68
BN 80	19	40	M6	21.5	6	100	80	120	M6	3	156	372	332	119	74	80	83
BN 90 S	24	50	M8	27	8	115	95	140	M8	3	176	425	375	133	98	98	95
BN 90 L	24	50	M8	27	8	115	95	140	M8	3	176	425	375	133	98	98	95
BN 100	28	60	M10	31	8	130	110	160	M8	3.5	195	477	417	142	98	98	119
BN 112	28	60	M10	31	8	130	110	160	M8	3.5	219	500	440	157	98	98	128
BN 132 S	38	80	M12	41	10	165	130	200	M10	4	258	600	520	193	118	118	142
BN 132 M	38	80	M12	41	10	165	130	200	M10	4	258	638	558	193	118	118	180

N.B.:

Per la versione BN..BA le dimensioni della scatola morsetti AD, AF, LL, V sono uguali al tipo BN..FD.

NOTE:

For motors type BN..BA, the terminal box sizes AD, AF, LL, V are the same as for BN..FD.

HINWEIS:

Bei der Version BN..BA sind die Maße des Klemmenkastens AD, AF, LL, V denen der Version BN..FD gleich.

REMARQUE :

Pour moteurs type BN..BA les dimensions de la boîte à bornes AD, AF, LL, V sont les mêmes de BN..FD.

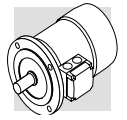

BN_BA

IM B5

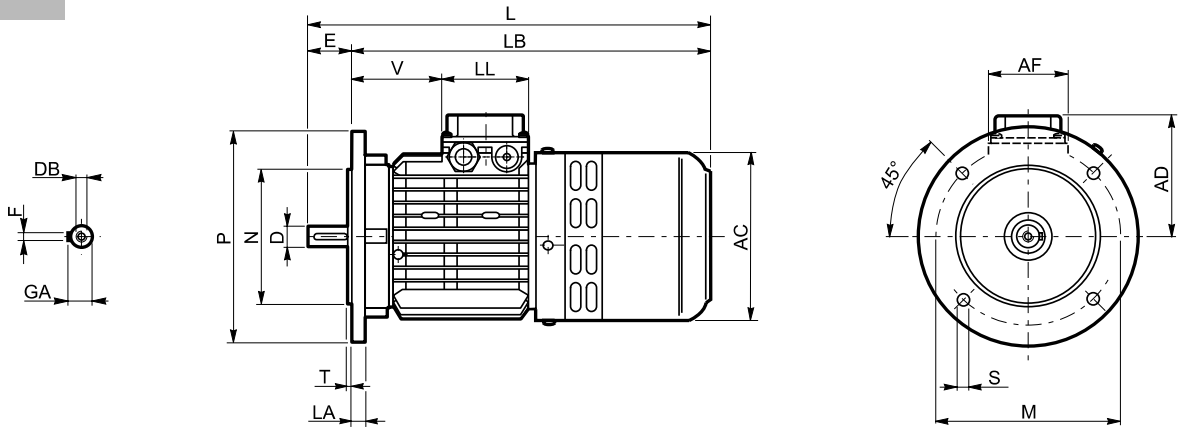

	Albero / Shaft / Welle / Arbre					Flangia / Flange / Flansch / Bride						Motore / Motor / Motor / Moteur						
	D DA	E EA	DB	GA GC	F FA	M	N	P	S	T	LA	AC	L	LB	AD	AF	LL	V
BN63	11	23	M4	12.5	4	115	95	140	9.5	3	10	124	298	275	95	74	80	28
BN 71	14	30	M5	16	5	130	110	160	9.5	3.5	10	138	327	297	108	74	80	68
BN 80	19	40	M6	21.5	6	165	130	200	11.5	3.5	11.5	156	372	332	119	74	80	83
BN 90 S	24	50	M8	27	8	165	130	200	11.5	3.5	11.5	176	425	375	133	98	98	95
BN 90 L	24	50	M8	27	8	165	130	200	11.5	3.5	11.5	176	425	375	133	98	98	95
BN 100	28	60	M10	31	8	215	180	250	14	4	14	195	477	417	142	98	98	119
BN 112	28	60	M10	31	8	215	180	250	14	4	15	219	500	440	157	98	98	128
BN 132 S	38	80	M12	41	10	265	230	300	14	4	16	258	600	520	193	118	118	142
BN 132 M	38	80	M12	41	10	265	230	300	14	4	16	258	638	558	193	118	118	180

N.B.:

Per la versione BN..BA le dimensioni della scatola morsetti AD, AF, LL, V sono uguali al tipo BN..FD.

NOTE:

For motors type BN..BA, the terminal box sizes AD, AF, LL, V are the same as for BN..FD.

HINWEIS:

Bei der Motor typ BN..BA sind die Maße des Klemmenkastens AD, AF, LL, V denen der Version BN..FD gleich.

REMARQUE :

Pour moteurs type BN..BA les dimensions de la boîte à bornes AD, AF, LL, V sont les mêmes de BN..FD.

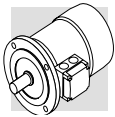

M

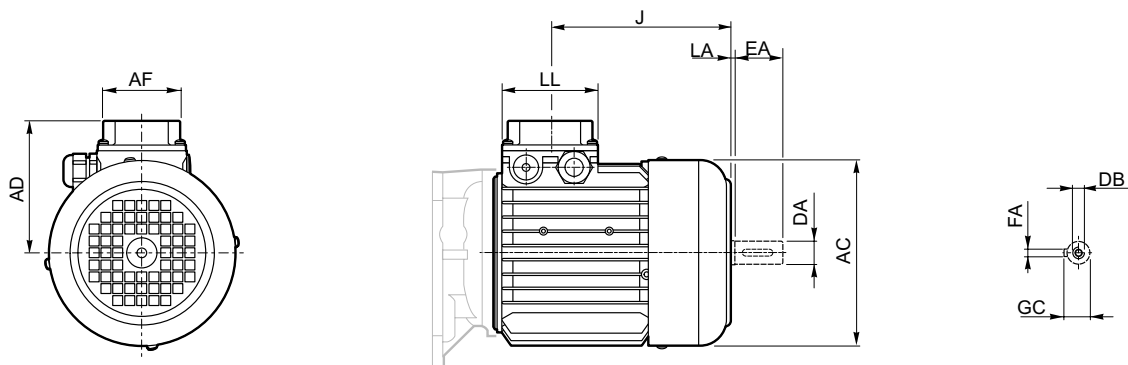

	AC	AD	AF	LL	J	DA	EA	LA	DB	GC	FA
M 0	110	91	74	80	91	9	20	2	M3	10.2	3
M 05	121	95	74	80	117	11	23	3	M4	12.5	4
M 1S	138	108	74	80	118	14	30	2	M5	16	5
M 1L	138	108	74	80	142	14	30	2	M5	16	5
M 2S	156	119	74	80	152	19	40	3	M6	21.5	6
M 3S	195	142	98	98	176.5	28	60	3	M10	31	8
M 3L	195	142	98	98	208.5	28	60	3	M10	31	8
M 4S	258	193	118	118	258.5	38	80	3	M12	41	10
M 4L	258	193	118	118	296.5	38	80	3	M12	41	10
M 4LC	258	193	118	118	331.5	38	80	3	M12	41	10
M 5S	310	245	187	187	341.5	38	80	4	M12	41	10
M 5L	310	245	187	187	385	38	80	4	M12	41	10

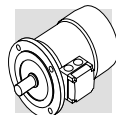

M_FD

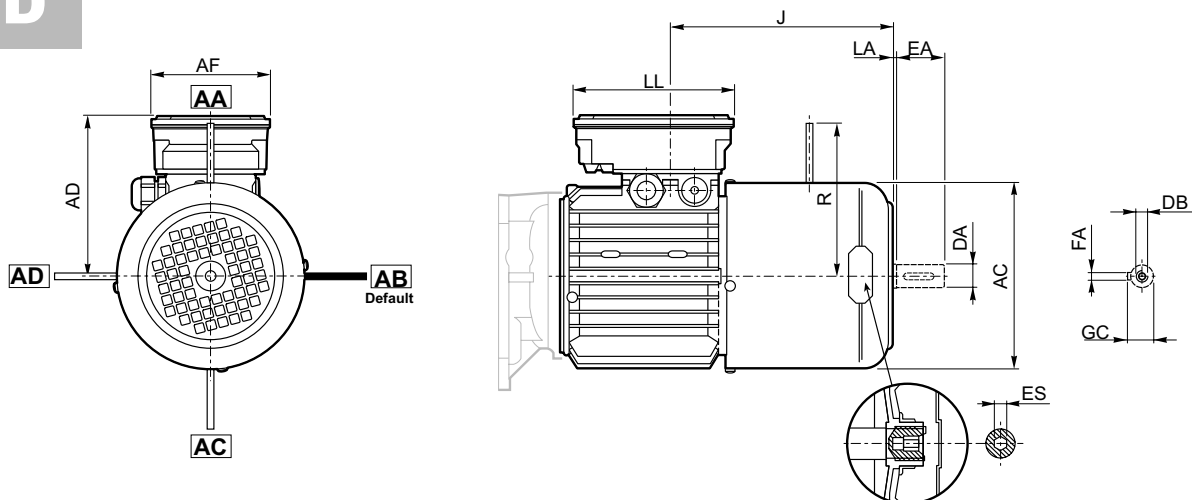

	AC	AD	AF	LL	J	R	DA	EA	LA	DB	GC	FA	ES
M 05	121	119	98	133	183	96	11	23	2	M4	12.5	4	5
M 1S	138	132	98	133	153	103	14	30	2	M5	16	5	5
M 1L	138	132	98	133	175	103	14	30	2	M5	16	5	5
M 2S	156	143	98	133	184	129	19	40	2	M6	21.5	6	5
M 3S	195	155	110	165	202	160	28	60	3	M10	31	8	6
M 3L	195	155	110	165	229	160	28	60	3	M10	31	8	6
M 4S	258	193	118	118	285	226	38	80	3	M12	41	10	6
M 4L	258	193	118	118	285	226	38	80	3	M12	41	10	6
M 4LC	258	193	118	118	431	226	38	80	3	M12	41	10	6
M 5S	310	245	187	187	481	266	38	80	4	M12	41	10	—
M 5L	310	245	187	187	525	266	38	80	4	M12	41	10	—

N.B.:

L'esagono ES non è presente con l'opzione PS.

NOTE:

The hexagonal socket "ES" is not available with the PS option.

HINWEIS:

Der Sechskant ES ist bei der Option PS nicht vorhanden.

REMARQUE :

L'hexagone ES n'est pas disponible avec l'option PS.

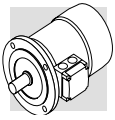

M_FA

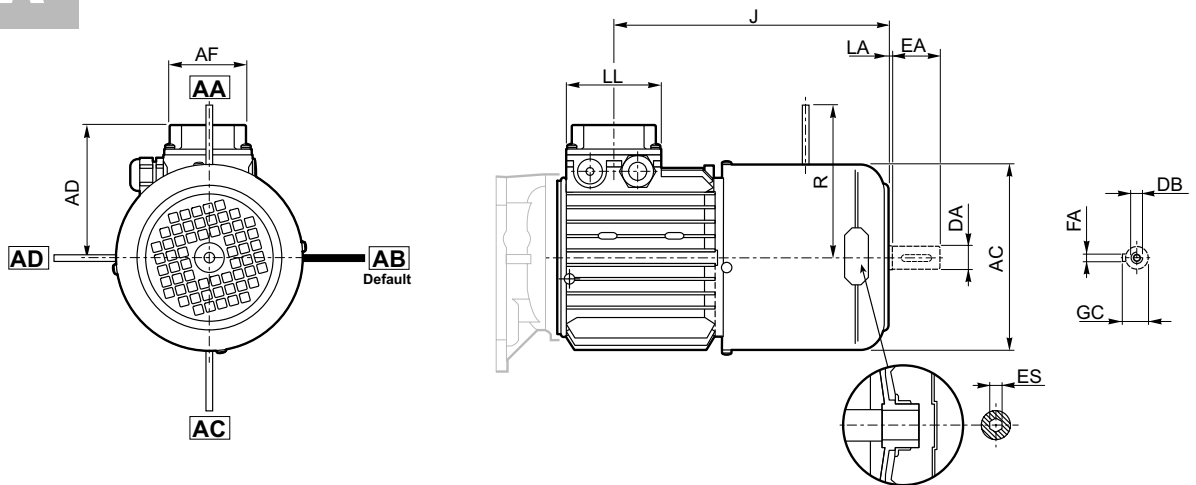

	AC	AD	AF	LL	J	R	DA	EA	LA	DB	GC	FA	ES
M 05	121	95	74	80	183	116	11	23	2	M4	12.5	4	5
M 1S	138	108	74	80	153	124	14	30	2	M5	16	5	5
M 1L	138	108	74	80	175	124	14	30	2	M5	16	5	5
M 2S	156	119	74	80	184	134	19	40	2	M6	21.5	6	5
M 3S	195	142	98	98	202	160	28	60	3	M10	31	8	6
M 3L	195	142	98	98	229	160	28	60	3	M10	31	8	6
M 4S	258	193	118	118	258	217	38	80	3	M14	41	10	6
M 4L	258	193	118	118	285	217	38	80	3	M14	41	10	6
M 4LC	258	193	118	118	431	217	38	80	3	M14	41	10	6
M 5S	310	245	187	187	481	247	38	80	4	M12	41	10	—
M 5L	310	245	187	187	525	247	38	80	4	M12	41	10	—

N.B.:

L'esagono ES non è presente con l'opzione PS.

NOTE:

The hexagonal socket "ES" is not available with the PS option.

HINWEIS:





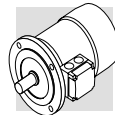

Der Sechskant ES ist bei der Option PS nicht vorhanden.

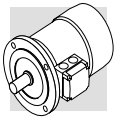
REMARQUE :

L'hexagone ES n'est pas disponible avec l'option PS.





R7				
	Descrizione	Description	Beschreibung	Description
 25	Quantità di lubrificante espressa da un'unica tabella.	<i>Lubrication pattern summarized in one chart only.</i>	Öfüllmengen in einer Tabelle zusammengefasst.	<i>Quantité de lubrifiant exprimé dans un unique tableau.</i>
 26	Corretto le posizioni di alcuni tappi di servizio.	<i>Revised the location of some oil plugs.</i>	Überarbeitete Lage der Ölschrauben.	<i>Corrigé les positions de quelques bouchons de service.</i>
 68 69	Alcuni abbinamenti motore-duttore rimossi nelle potenze 11 kW e 15 kW.	<i>Removed a few 11 kW and 15 kW gearmotor combinations.</i>	Es wurde einige 11kW und 15kW Getriebemotorkombinationen herausgenommen.	<i>Quelques accouplement motoreducteurs ôtées dans les puissances 11 kW et 15 kW.</i>
 96 97	Tabella predisposizioni possibili corretta per C 702, C 803 e C 903.	<i>Listing of available motors for C 702, C 803 and C 903 adjourned.</i>	Auslistung der verfügbaren Motoren für C702, C803, C903 ist neu bearbeitet.	<i>Tableau predispositions possibles corrigée pour C 702, C 803 et C 903.</i>
 110	Nuovo layout disegni d'installazione.	<i>New layout for the installation drawings.</i>	Neues Layout für Montagezeichnung.	<i>Nouveau layout plans d'installation.</i>
 142	Inserita sezione motori aggiornata.	<i>Electric motor section adjourned with the latest corrections.</i>	Abschnitt elektr. Motoren neu bearbeitet.	<i>Inserée section moteurs mis à jour.</i>

Questa pubblicazione annulla e sostituisce ogni precedente edizione o revisione. Ci riserviamo il diritto di apportare modifiche senza preavviso. È vietata la produzione anche parziale senza autorizzazione.

This publication supersedes and replaces any previous edition and revision. We reserve the right to implement modifications without notice. This catalogue cannot be reproduced, even partially, without prior consent.

Diese Veröffentlichung annulliert und ersetzt jeder hergehende Edition oder Revision. BONFIGLIOLI behält sich das Recht vor, Änderungen ohne vorherige Informationen durchzuführen.

Cette publication annule et remplace toutes les autres précédentes. Nous nous réservons le droit d'apporter toutes modifications à nos produits. La reproduction et la publication partielle ou totale de ce catalogue est interdite sans notre autorisation.

SEDE CENTRALE - HEADQUARTERS**BONFIGLIOLI RIDUTTORI S.p.A.**

Via Giovanni XXIII, 7/A
40012 Lippo di Calderara di Reno - Bologna (ITALY)
Tel. (+39) 051 6473111
Fax (+39) 051 6473126
www.bonfiglioli.com
bonfiglioli@bonfiglioli.com

SALES DEPARTMENT**INDUSTRIAL TRANSMISSION & AUTOMATION DRIVES****BONFIGLIOLI RIDUTTORI S.p.A.**

Via Giovanni XXIII, 7/A
40012 Lippo di Calderara di Reno - Bologna (ITALY)
Tel. (+39) 051 6473111 - Fax (+39) 051 6473126
bonfiglioli@bonfiglioli.com

SALES DEPARTMENT**MOBILE EQUIPMENT DRIVES****BONFIGLIOLI RIDUTTORI S.p.A.**

Via Enrico Mattei, 12 - Z.I. Villa Selva - 47100 Forlì (ITALY)
Tel. (+39) 0543 789111
Fax (+39) 0543 789242 - 0543 789245
trasmital@bonfiglioli.com

UFFICI VENDITE ITALIA - ITALY SALES OFFICES

PARMA - Largo Luca Ganzi, 9/E
Tel. 0521 987275 - Fax 0521 987368

DEPOSITI IN ITALIA - STOCK HOUSES IN ITALY**ASSAGO (MILANO)**

Via Idiomi ang. Donizetti
Tel. 02 48844710 / 02 4883395 - Fax 02 48844750 / 02 4883874

TORINO - Corso Susa, 242 - Palazzo Prisma 88 - 10098 Rivoli
Tel. 011 9585116 - Fax 011 9587503

MILANO - Via Idiomi ang. Donizetti - 20094 Assago - Milano
Tel. 0245716930 - Fax 0245712745

PADOVA - IX Strada, 1 - Zona Industriale
Tel. 049 8070911 - Fax 049 8074033 / 049 8073883

BONFIGLIOLI WORLDWIDE & BEST PARTNERS**AUSTRALIA**

BONFIGLIOLI TRANSMISSION (Aust) Pty Ltd.
48-50 Adderley St. (East) - Auburn (Sydney) N.S.W. 2144
Tel. (+61) 2 8748 4400 - Fax (+61) 2 9748 8740
P.o. Box 6705 Silverwater NSW 1811
www.bonfiglioli.com.au - bta1@bonfiglioli.com.au

BELGIUM BEST

N.V. ESCO TRANSMISSION S.A.
Culliganlaan 3 - 1831 Machelem Diegem
Tel. 0032 2 7204880 - Fax 0032 2 7212827
Tlx 21930 Escopo B
www.escotrans.be - info@escotrans.be

CANADA

BONFIGLIOLI CANADA INC.
2-7941 Jane Street - Concord, ONTARIO L4K 4L6
Tel. (+1) 905 7384466 - Fax (+1) 905 7389833
www.bonfigliolicanada.com - sales@bonfigliolicanada.com

GREAT BRITAIN

BONFIGLIOLI UK Ltd
Unit 3 Colemeadow Road - North Moons Moat
Redditch. Worcestershire B98 9PB
Tel. (+44) 1527 65022 - Fax (+44) 1527 61995
www.bonfiglioli.co.uk - marwaha@bonfiglioli.com

FRANCE

BONFIGLIOLI TRANSMISSIONS S.A.
14 Rue Eugène Pottier BP 19
Zone Industrielle de Moimont II - 95670 Marly la Ville
Tel. (+33) 1 34474510 - Fax (+33) 1 34688800
www.bonfiglioli.fr - btf@bonfiglioli.fr

GERMANY

BONFIGLIOLI GETRIEBE GmbH
Hamburger Straße 18 - 41540 Dormagen
Tel. (+49) 2133 50260 - Fax (+49) 2133 502610
www.bonfiglioli.de - bonfiglioli.getriebe@bonfiglioli.de

VECTRON Elektronik GmbH

Europark Fichtenhain A 6 47807 Krefeld
Tel. (+49) 2151 83960 - Fax (+49) 2151 839699
www.vectron.net - info@vectron.net

GREECE

BONFIGLIOLI HELLAS S.A.
O.T. 48A T.O. 230 - C.P. 570 22, Industrial Area - Thessaloniki
Tel. (+30) 2310 796456 - Fax (+30) 2310 795903
www.bonfiglioli.gr - bonfigr@otenet.gr

HOLLAND BEST

ELSTO AANDRIJFTECHNIEK
Loosterweg, 7 - 2215 TL Voorhout
Tel. (+31) 252 219 123 - Fax (+31) 252 231 660
www.elsto.nl - imfo@elsto.nl

HUNGARY BEST

AGISYS AGITATORS & TRANSMISSIONS Ltd
2045 Törökbálint, Tó u.2. Hungary
Tel. +36 23 50 11 50 - Fax +36 23 50 11 59
www.agisys.hu - info@agisys.com

INDIA

BONFIGLIOLI TRANSMISSIONS PVT Ltd.
PLOT AC7-AC11 Sidco Industrial Estate
Thirumudivakkam - Chennai 600 044
Tel. +91(0)44 24781035 / 24781036 / 24781037
Fax +91(0)44 24780091 / 24781904
www.bonfiglioli.co.in - bonfig@vsnl.com

NEW ZEALAND BEST

SAECO BEARINGS TRANSMISSION
36 Hastie Avenue, Mangere - Po Box 22256, Otahuhu - Auckland
Tel. +64 9 634 7540 - Fax +64 9 634 7552 - mark@saeco.co.nz

POLAND BEST

POLPACK Sp. z o.o. - Ul. Chrobrego 135/137 - 87100 Torun
Tel. 0048.56.6559235 - 6559236 - Fax 0048.56.6559238
www.polpack.com.pl - polpack@polpack.com.pl

RUSSIA BEST

FAM
19/21, nab.reki Smolenki, V.O. - 199048, St. Petersburg
Tel. +7 812 3039789 - Fax +7 812 3271454
www.fam-drive.ru - fam@nm.ru

SPAIN

TECNOTRANS SABRE S.A.
Pol. Ind. Zona Franca sector C, calle F, nº6 08040 Barcelona
Tel. (+34) 93 4478400 - Fax (+34) 93 3360402
www.tecnotrans.com - tecnotrans@tecnotrans.com

SOUTH AFRICA

BONFIGLIOLI POWER TRANSMISSION Pty Ltd.
55 Galaxy Avenue, Linbro Business Park - Sandton
Tel. (+27) 11 608 2030 OR - Fax (+27) 11 608 2631
www.bonfiglioli.co.za - bonfigsales@bonfiglioli.co.za

SWEDEN

BONFIGLIOLI SKANDINAVIEN AB
Kontorsgatan - 234 34 Lomma
Tel. (+46) 40 412545 - Fax (+46) 40 414508
www.bonfiglioli.se - info@bonfiglioli.se

THAILAND BEST

K.P.T MACHINERY (1993) CO.LTD.
259/83 Soi Phiboonves, Sukhumvit 71 Rd. Phrakonong-nur,
Wattana, Bangkok 10110
Tel. 0066.2.3913030/7111998
Fax: 0066.2.7112852/3811308/3814905
www.kpt-group.com - sales@kpt-group.com

USA

BONFIGLIOLI USA INC
1000 Worldwide Boulevard - Hebron, KY 41048
Tel.: (+1) 859 334 3333 - Fax: (+1) 859 334 8888
www.bonfiglioliusa.com
industrialsales@bonfiglioliusa.com - mobilesales@bonfiglioliusa.com

VENEZUELA BEST

MAQUINARIA Y ACCESORIOS IND.-C.A.
Calle 3B - Edif. Comindu - Planta Baja - Local B
La Urbina - Caracas 1070
Tel. 0058.212.2413570 / 2425268 / 2418263
Fax: 0058.212.2424552 - Tlx: 24780 Maica V
www.maica-ve.com - maica@telcel.net.ve

Distribuzione esclusiva ricambi Bonfiglioli / Spare parts Bonfiglioli

B.R.T.

Via Castagnini, 2-4 - Z.I. Bargellino 40012 Calderara di Reno (BO) - Italy
Tel. 051.727844 - Fax 051.727066 - brt@bonfiglioli.com - www.brtbonfiglioliricambi.it

Bonfiglioli Riduttori sceglie lubrificanti SHELL



Bonfiglioli Riduttori recommends SHELL lubricants